

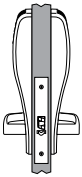

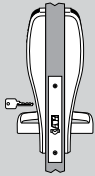

Functions

Access
800 | WI1

ML20800 WI1 Mortise Locks

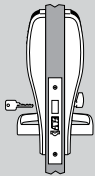
Outside	Inside	Series/Function	Type	Function Description
		ML20833 No Key Override* No Deadbolt	Entry	<ul style="list-style-type: none"> • Deadlocking latch • Latch retracted by inside lever at all times • Outside lever rigid except when in "passage" mode or valid user code entered
		ML20834 With Key Override No Deadbolt	Entry	<ul style="list-style-type: none"> • Deadlocking latch • Latch retracted by inside lever at all times • Outside lever rigid except when in "passage" mode or valid user code entered • Key outside retracts latch • No deadbolt function
		ML20835 No Key Override* With Deadbolt	Entry	<ul style="list-style-type: none"> • Deadlocking latch • Latch and deadbolt retracted by inside lever at all times • Outside lever rigid except when in "passage" mode or valid user code entered • When deadbolt thrown, outside lever operable only with emergency code or master code
		ML20836 With Key Override With Deadbolt	Entry	<ul style="list-style-type: none"> • Deadlocking latch • Latch and deadbolt retracted by inside lever and deadbolt at all times • Outside lever rigid except when in "passage" mode or valid user code entered • Key outside projects or retracts deadbolt and retracts latch • When deadbolt projected, outside lever operable only with emergency code, master code, or key (key retracts deadbolt and latch)

* Outside escutcheon will not have cylinder hole cutout

Features & Functions

CL33800 W11 Cylindrical Lock

Access 800 | W11

Certification/Compliance

ANSI/BHMA

Meets A156.2 Grade 1 requirements.

Federal

Meets FF-H-106C.

California State Reference Code

(Formerly Title 19, California State Fire Marshal Standard) All levers with returns comply; levers return to within 1/2" (13mm) of door face.

C-UL US

All locks with 1/2" (13mm) throw latchbolt listed for A label and lesser class 4' x 10' single doors. All locks with 3/4" (19mm) throw latchbolt listed for A label and lesser class 8' x 10' pairs of doors. Letter F and UL symbol on latch front indicate listing.

Any retrofit or other field modification to a fire rated opening can potentially impact the fire rating of the opening, and Corbin Russwin, Inc. makes no representations or

warranties concerning what such impact may be in any specific situation. When retrofitting any portion of an existing fire rated opening, or specifying and installing a new fire-rated opening, please consult with a code specialist or local code official (Authority Having Jurisdiction) to ensure compliance with all applicable codes and ratings.

Credential Quick Codes

Description	Specify
Prox Only	M802
Keypad/Prox	M803
iCLASS® Only	M812
Keypad/iCLASS	M813

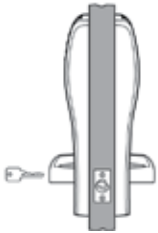
Outside	Inside	Series/Function	Type	Function Description
		CL33834 With Key Override	Entry	<ul style="list-style-type: none"> Latch retracted by inside lever at all times. Key outside retracts latch. Outside lever locked (freewheeling) except when in "passage" mode or valid user code entered.

Escutcheons

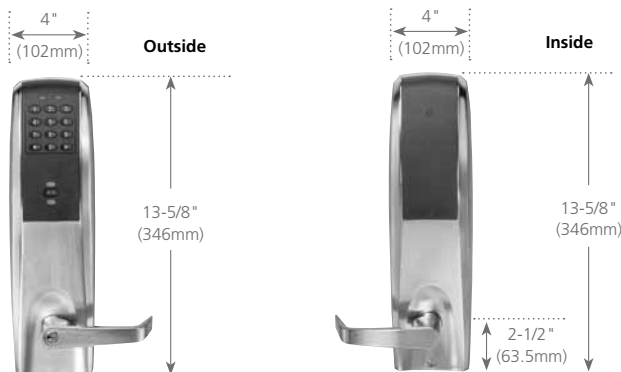

- Zinc die cast
- Lowest projection 11/16" (17mm) less lever
- Highest projection 1-5/8" (41mm)
- Tactile keypad
- Operating temperature:
 - 125 kHz proximity products: -40° F (-40°C) to 135° F (57°C)
 - 13.56 MHz iCLASS products: -13°F (-25°C) to 151°F (66°C)
- LEDs indicate valid/invalid entries
- Keys/buttons with double shot mold construction prevents wear
- Freewheeling outside lever when locked

Functions

ED5000 x 9800/9M800 WI1 Exit Device

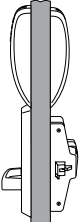
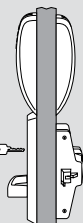
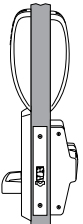
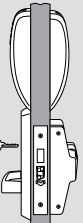
Outside	Inside	Series/Function	Type	Function Description
		ED5200(A)N & ED5200S(A)N *9833 No Key Override**	Entry	<ul style="list-style-type: none"> • Latch retracted by inside push pad at all times • Outside lever locked (freewheeling) except when in passage mode or valid user code entered
		ED5200(A)N & ED5200S(A)N *9834 With Key Override	Entry	<ul style="list-style-type: none"> • Latch retracted by inside push pad at all times • Outside lever locked (freewheeling) except when in passage mode or valid user code entered • Outside cylinder override allows lever to retract latch
		ED5633(A)LN *9M833 No Key Override**	Entry	<ul style="list-style-type: none"> • Latch retracted by inside push pad at all times • Outside lever rigid except when in passage mode or valid user code entered
		ED5634(A)LN *9M834 With Key Override	Entry	<ul style="list-style-type: none"> • Latch retracted by inside push pad at all times • Outside lever rigid except when in passage mode or valid user code entered • Outside cylinder override retracts latch

Note: 9M833 and 9M834 cannot be retrofitted to an existing ED5600 Series mortise device. When ordered as "Trim Only", 9M833 and 9M834 will be furnished with the appropriate mortise lock.

*Lever Design (prefix)

** Outside escutcheon will not have cylinder hole cutout.