



Nomenclature Made Easy!

Conversion Chart

Nomenclature Made Easy! Conversion Chart

Corbin Russwin has introduced a new simplified product numbering system that makes it easy to identify, specify and order a complete line of architectural hardware. This "Nomenclature Made Easy" Conversion Chart is provided as a helpful cross reference bridge from the Corbin and the Russwin languages to the new Corbin Russwin.

Follow these easy conversions and you'll soon be speaking the new Corbin Russwin.

Table of Contents

Mortise Locksets	
Series	2
Function	3
Trim Designation	4 - 19
Electromechanical Mortise Locksets	20
Cylindrical and Unit Locksets	
Series	21
Function	22
Trim Designation	23 - 24
Padlocks	25
Deadlocks	26
Push-Pull Latches	26
Pushbar Exit Devices	
Series/Function	27 - 28
Trim Designation	29 - 33
Crossbar Exit Devices	
Series/Function	34 - 36
Trim Designation	37 - 46
Electromechanical Mortise Crossbar Exit Devices	47
Mullions	47
Cylinders	48 - 54
Door Closers	55
Electromechanical Door Closers	55
Door Holders	56
Electromagnetic Door Releases	56
Finishes	57

Locksets

Nomenclature Made Easy!
Conversion Chart

Mortise Locksets

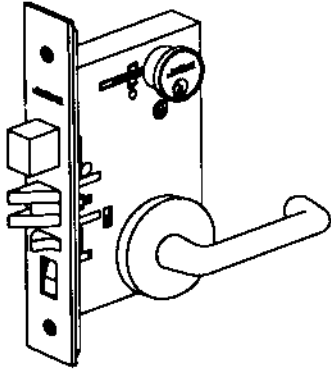

Ordering Configuration

Qty	Series/Function	Trim	Finish	Hand	Options
100	ML2255	LSM	626	LH	D214

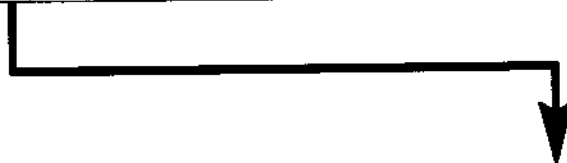

Series Numbers

If you know . . .

. . . then you know

Corbin	Russwin	Description	Corbin Russwin
9200/9400	4000/6000	Mortise Lockset	ML2200
9500/9700	5000/7000	Mortise Lockset	ML2200
9700T	T7000	Mortise Lockset (High Security)	ML2200HS
9800	7400	Mortise Lockset (Master Ring)	ML2200

Nomenclature Made Easy!
Conversion Chart

Mortise Locksets

Ordering Configuration

Qty	Series/Function	Trim	Finish	Hand	Options
100	ML2255	LSM	626	LH	D214

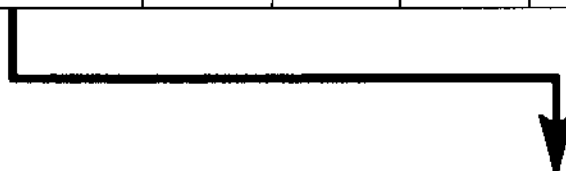

Function Numbers

If you know . . .

. . . then you know

Corbin	Russwin	Description	Corbin	Russwin
10	25	Passage or Closet	10	
20	39	Privacy, Bedroom, Bath	20	
E20	69	Privacy, Bedroom, Bath	30	
51	56	Entrance or Office	51	
55	45	Classroom	55	
57	59	Storeroom or Closet	57	
29	34	Hotel	29	
11	01	Deadlock	11	
12	02	Deadlock	12	
13	03	Deadlock	13	
22	22	Store Door	22	
54	42	Entrance, Public Restroom	42	
43	48	Entry or Apartment	48	
65	61	Dormitory, Entry, Storeroom	65	
49	67	Apartment, Dormitory	67	
23	24	Entrance or Storeroom	24	

Locksets

Nomenclature Made Easy!
Conversion Chart

Mortise Locksets

Ordering Configuration



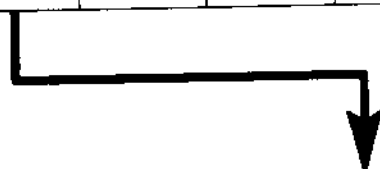

Qty	Series/Function	Trim	Finish	Hand	Options
100	ML2255	RSA	626	LH	D214



Trim Designation

If you know . . .

. . . then you know

Corbin	Russwin		Corbin Russwin
771L Flute	L Regis		RSB
771L2 Flute	L2 Regis		RWA
771L3 Flute	L3 Regis		RWB
771L4 Flute	L4 Regis		RSA

Nomenclature Made Easy!
Conversion Chart

Mortise Locksets

Trim Designation

If you know . . .

. . . then you know

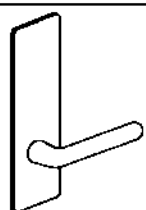
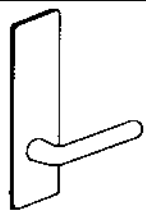
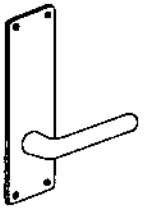
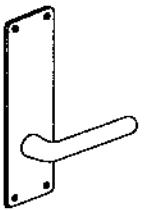
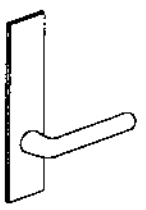
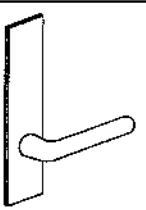
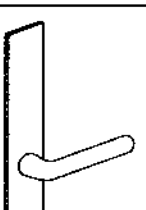
Corbin	Russwin		Corbin Russwin
781L2 Washington	L2 RegRad		RWM
781L4 Washington	L4 RegRad		RSM
741L2 Washington	L2 RegRoc		RWN
741L4 Washington	L4 RegRoc		RSN
791L2 Lincoln	L2 RegRex		RWP
791L4 Lincoln	L4 RegRex		RSP
772L Cambridge	RegMo		RSR





Nomenclature Made Easy!
Conversion Chart

Mortise Locksets

Trim Designation

If you know . . .

. . . then you know

Corbin	Russwin		Corbin	Russwin
779L Curl	L Lustra		LSB	
779L2 Curl	L2 Lustra		LWA	
779L3 Curl	L3 Lustra		LWB	
779L4 Curl	L4 Lustra		LSA	

Nomenclature Made Easy!
Conversion Chart

Mortise Locksets

Trim Designation

If you know . . .

. . . then you know

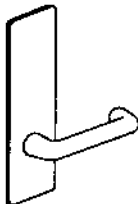
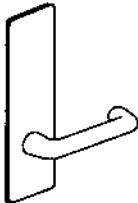
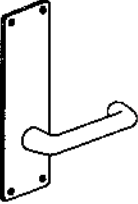
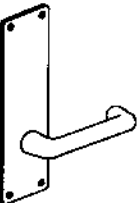
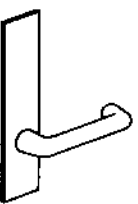
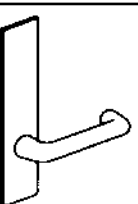
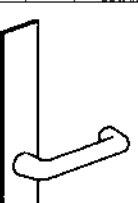
Corbin	Russwin		Corbin Russwin
789L2 Washington	L2 LusRad		LWM
789L4 Washington	L4 LusRad		LSM
749L2 Washington	L2 LusRoc		LWN
749L4 Washington	L4 LusRoc		LSN
799L2 Lincoln	L2 LusRex		LWP
799L4 Lincoln	L4 LusRex		LSP
773L Boston	LusMo		LSR

Locksets



Nomenclature Made Easy!
Conversion Chart

Mortise Locksets

Trim Designation

If you know . . .

. . . then you know

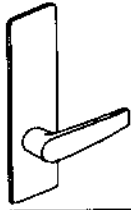
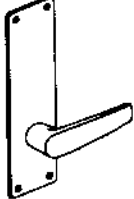
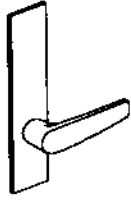
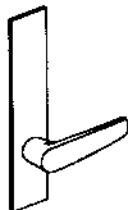
Corbin	Ruswin		Corbin Ruswin
975L4 Boston	L4 Armstrong		ASA
975L Boston	L Armstrong		ASB
985L4 Washington	L4 ArmRad		ASM
748L4 Washington	L4 ArmRoc		ASN
995L4 Lincoln	L4 ArmRex		ASP
965L Boston	L4 ArmMo		ASR



Nomenclature Made Easy!
Conversion Chart

Mortise Locksets

Trim Designation

If you know . . .

. . . then you know

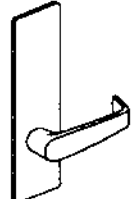
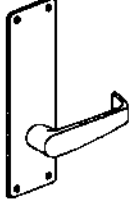
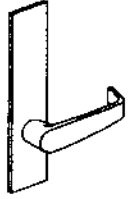
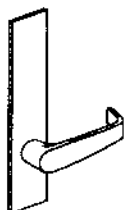
Corbin	Russwin		Corbin Russwin
977L4 Sacramento	L4 Newport		NSA
977L Sacramento	L Newport		NSB
987L4 Washington	L4 NewRad		NSM
747L4 Washington	L4 NewRoc		NSN
997L4 Lincoln	L4 NewRex		NSP
967L Sacramento	NewMo		NSR

Locksets



Nomenclature Made Easy!
Conversion Chart

Mortise Locksets

Trim Designation

If you know . . .

. . . then you know

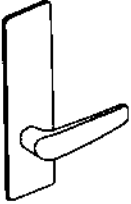
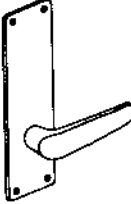
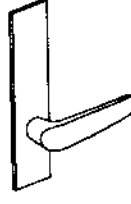
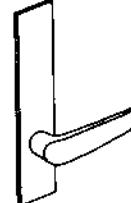
Corbin	Russwin		Corbin Russwin
765L4 Plaza	L4 Citation		CSA
765L Plaza	L Citation		CSB
710L4 Washington	L4 CitRad		CSM
745L4 Washington	L4 CitRoc		CSN
709L4 Lincoln	L4 CitRex		CSP
775L Calais	CitMo		CSR



Nomenclature Made Easy!
Conversion Chart

Mortise Locksets

Trim Designation

If you know . . .

. . . then you know

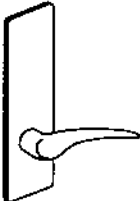
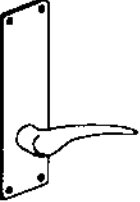
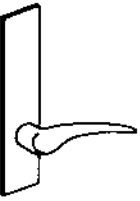
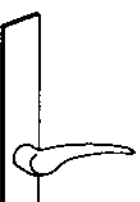

Corbin	Russwin		Corbin Russwin
760L4 Stratford	L4 Dirke		DSA
760L Stratford	L Dirke		DSB
780L4 Washington	L4 DirRad		DSM
740L4 Washington	L4 DirRoc		DSN
790L4 Lincoln	L4 DirRex		DSP
770L Seattle	DirMo		DSR

Locksets

Nomenclature Made Easy!
Conversion Chart

Mortise Locksets

Trim Designation

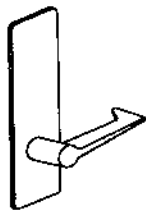
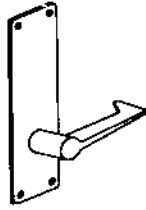
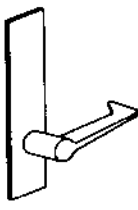
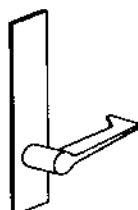







If you know then you know	
Corbin	Russwin	Corbin	Russwin
766L4 Essex	L4 Tornay		ESA
766L Essex	L Tornay		ESB
786L4 Washington	L4 TorRad		ESM
746L4 Lincoln	L4 TorRoc		ESN
796L4 Lincoln	L4 TorRex		ESP
776L Cherbourg	TorMo		ESR

Mortise Locksets

Trim Designation

If you know . . .

. . . then you know



Corbin	Russwin		Corbin Russwin
863 Global	W4 Ashford		GRC
833 Global	W43 Ashford		GWC
864 Global	W4 Albany		GRD
834 Global	W43 Albany		GWD
868 Global	W4 Andover		GRE
838 Global	W43 Andover		GWE
783 Dallas	B23KS Ronde		GSA
783 Dallas	L Ronde		GSB

Mortise Locksets

Trim Designation

If you know . . .

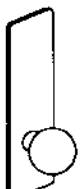
. . . then you know

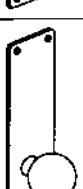
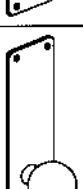



Corbin	Russwin		Corbin Russwin
710 (D) Washington	W4 A-Rad		GRM
710 (A) Washington	W43 A-Rad		GWM
710 (K) Washington	K-Rad		GSM
700 (D) Washington	W4 A-Rock		GRN
700 (A) Washington	W43 A-Rock		GWN
700 (K) Washington	K-Rock		GSN

Mortise Locksets

Trim Designation

If you know . . .

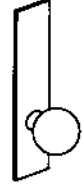
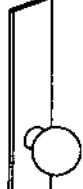
. . . then you know







Corbin	Russwin		Corbin Russwin
709 (D) Lincoln	W4 A-Rex		GRP
709 Lincoln	W43 A-Rex		GWP
709 (K) Lincoln	K-Rex		GSP
764 (D) LeMans	W4 A-Mo		GRR
764 (A) LeMans	W43 A-Mo		GWR
764 LeMans	B2KS Ron Mo		GSR

Mortise Locksets

Trim Designation

If you know . . .

. . . then you know

Corbin	Russwin		Corbin	Russwin
865 Pierce	W4 Belmont		BRC	
835 Pierce	W43 Belmont		BWC	
866 Pierce	W4 Brockton		BRD	
836 Pierce	W43 Brockton		BWD	
869 Pierce	W4 Burbank		BRE	
839 Pierce	W43 Burbank		BWE	





Nomenclature Made Easy!
Conversion Chart

Mortise Locksets

Trim Designation

If you know . . .

. . . then you know





Corbin	Ruswin		Corbin Ruswin
710 (E) Washington	W4 B-Rad		BRM
710 (B) Washington	W43 B-Rad		BWM
700 (E) Washington	W4 B-Rock		BRN
700 (B) Washington	W43 B-Rock		BWN

Mortise Locksets

Trim Designation

If you know . . .

. . . then you know

Corbin	Russwin		Corbin Russwin
709 (E) Lincoln	W4 B-Rex		BRP
709 (B) Lincoln	W43 B-Rex		BWP
764 (E) LeMans	W4 B-Mo		BRR
764 (B) LeMans	W43 B-Mo		BWR





Nomenclature Made Easy!
Conversion Chart

Mortise Locksets

Trim Designation

If you know . . .

. . . then you know

Corbin	Russwin		Corbin Russwin
710 (S) Washington	S-Rad		YWM
700 (S) Washington	S-Rock		YWN
709 (S) Lincoln	S-Rex		YWP
764 (S) LeMans	S-Mo		YWR

High Security Mortise Locksets

Trim Designation

If you know . . .

. . . then you know

Corbin	Russwin		Corbin Russwin
Surety	Newgate		SST

Locksets

Nomenclature Made Easy!
Conversion Chart

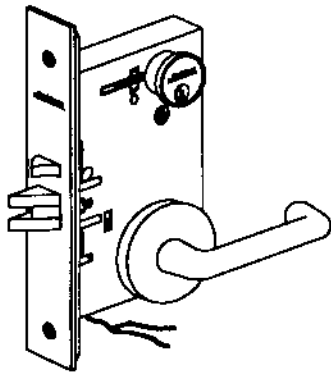

Electromechanical Mortise Locksets

Ordering Configuration

Qty	Series/Function	Trim	Finish	Hand	Options
100	ML22904	LSM	626	LH	D214

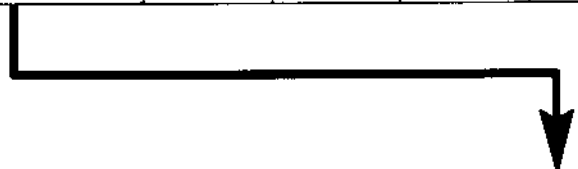

Series/Function Numbers

If you know . . .

. . . then you know

Corbin	Ruswin	Description	Corbin	Ruswin
9540 ECL	5084 ECL	Electrically Controlled Mortise Lockset	ML22910	
9541 ECL	5088 ECL	Electrically Controlled Mortise Lockset	ML22920	
9542 ECL	5086 ECL	Electrically Controlled Mortise Lockset	ML22901	
9546 ECL	5082 ECL	Electrically Controlled Mortise Lockset	ML22903	
9530 ECL	5083 ECL	Electrically Controlled Mortise Lockset	ML22930	
9531 ECL	5087 ECL	Electrically Controlled Mortise Lockset	ML22940	
9532 ECL	5085 ECL	Electrically Controlled Mortise Lockset	ML22904	
9536 ECL	5081 ECL	Electrically Controlled Mortise Lockset	ML22905	
9592 ECA	5092 ECA	Electrically Controlled Frame Actuator	ML22906	
9594 ECA	5094 ECA	Electrically Controlled Frame Actuator	ML22950	
9596 ECA	5096 ECA	Electrically Controlled Frame Actuator	ML22907	
9598 ECA	5098 EOA	Electrically Controlled Frame Actuator	ML22960	
9591 ECA	5091 ECA	Electrically Controlled Frame Actuator	ML22908	
9593 ECA	5093 ECA	Electrically Controlled Frame Actuator	ML22970	
9595 ECA	5095 ECA	Electrically Controlled Frame Actuator	ML22909	
9597 ECA	5097 ECA	Electrically Controlled Frame Actuator	ML22980	

**Nomenclature Made Easy!
Conversion Chart**

Cylindrical and Unit Locksets

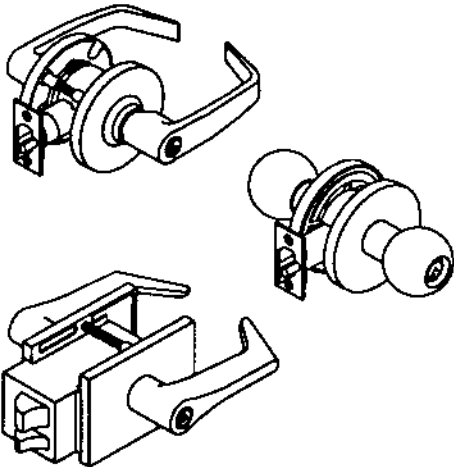

Ordering Configuration

Qty	Series/Function	Trim	Finish	Hand	Options
100	CL3455	LSM	626	LH	D214

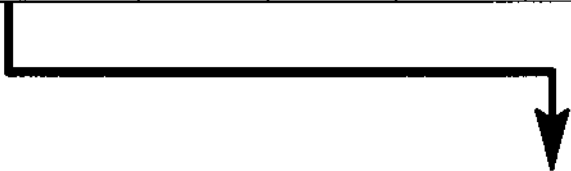

Series Numbers

If you know . . .

. . . then you know

Corbin	Russwin	Description	Corbin	Russwin
700	900	Security Bolt Lever Lock	CL3200	
800	800	Cylindrical Lever Lock	CL3400	
400	400	Cylindrical Knob Lock	CK4200	
6600	3400	Cylindrical Knob Lock	CK4400	
300	500	Unit Lock	UT5200	

Nomenclature Made Easy!
Conversion Chart

Cylindrical and Unit Locksets

Ordering Configuration

Qty	Series/Function	Trim	Finish	Hand	Options
100	CL3455	ASD	626	LH	D214

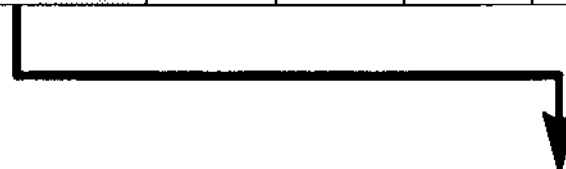

Function Numbers



If you know . . .

. . . then you know



Corbin	Russwin	Description	Corbin	Russwin
10	10	Passage or Closet	10	
20	20	Privacy, Bedroom, Bath	20	
20Y	ER20, ER21	Privacy, Bedroom, Bath	30	
40, 41	22	Patio or Privacy	40	
51	40, 51	Entrance or Office	51	
61	46, 61	Office or Privacy	61	
55	40 ^{5/8} , 45, 55	Classroom	55	
57	52, 57	Storeroom or Closet	57	
32	32, 52 ^{1/2}	Utility, Asylum, Inst.	32	
54	46 ^{1/2} , 54	Apt., Exit or Toilet	72	
88	48 ^{1/2} , 88	Store Door	82	
93	93	Service Station	93	
29	33EM, 29	Hotel	29	
14, 1/2DT	14, 1/2DT	Half Dummy Trim	50	
15, D, PRDT	15, D, PRDT	Full Dummy Trim	70	
11 ^{1/4} , 80	16, 80	Passage Lever, Blank Plate	80	
81	81	Keyed Lever, Blank Plate	81	
90	90	Passage Lever, Turnpiece	90	
91	91	Keyed Lever, Turnpiece	91	
75	63	Dormitory	75	

Cylindrical and Unit Locksets



Security Bolt Lever Lockset Trim Designation

If you know then you know	
Corbin	Russwin	Corbin Russwin	
975L Boston	Armstrong		ASD
977L Sacramento	Newport		NSD

Extra Heavy Duty Lever Lockset Trim Designation

If you know then you know	
Corbin	Russwin	Corbin Russwin	
75P	75P		ASD – Brass
75Z	75Z		AZD – Zinc
77P	77P		NSD – Brass
77Z	77Z		NZD – Zinc



Heavy Duty Knob Lockset Trim Designation

If you know then you know	
Corbin	Russwin	Corbin Russwin	
863 Global	Ashford		GRC
864 Global	Albany		GRD
868 Global	Andover		GRE

Cylindrical and Unit Locksets Heavy Duty Knob Lockset Trim Designation

If you know . . .



. . . then you know

Corbin	Ruswin		Corbin Ruswin
865 Pierce	Belmont		BRC
866 Pierce	Brockton		BRD
869 Pierce	Burbank		BRE

Standard Duty Knob Lockset Trim Designation

If you know . . .



. . . then you know

Corbin	Ruswin		Corbin Ruswin
363 Global	Austin		GWC
365 Pierce	Branford		BWC

Unit Lockset Trim Designation

If you know . . .

. . . then you know

Corbin	Ruswin		Corbin Ruswin
964 Global	Ashford		GRE
966 Pierce	Belmont		BRE
912R	912R		ESE

Nomenclature Made Easy!
Conversion Chart



Padlocks Ordering Configuration

Qty	Number	Options
10	PL5100-212	



Numbers

If you know . . .

. . . then you know

Corbin	Russwin	Description	Corbin	Russwin
2863	2863	Standard brass shackle		PL5100
2863 A	2863 A	Standard steel shackle		PL5000
2863 H	2863 H	Long brass shackle		PL5100-212
2863 AH	2863 AH	Long steel shackle		PL5000-212
82863	82863	Standard brass shackle		PL5180
82863 A	82863 A	Standard steel shackle		PL5080
82863 H	82863 H	Long brass shackle		PL5180-258
82863 AH	82863 AH	Long steel shackle		PL5080-258
NA prefix	NA prefix	Non-assembled (not for IC model)	Option M46	
C suffix	C suffix	Chain (all models)	Option M44	
W8 prefix	W8 prefix	High Security IC		PL5090 Series
8 prefix + LC suffix	8 prefix + LC suffix	IC Less Core		PL5070 Series

Deadlocks and Push-Pull Latches

Nomenclature Made Easy!
Conversion Chart

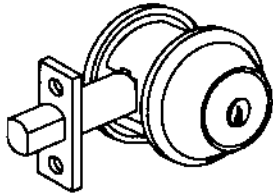

Deadlocks Ordering Configuration

Qty	Series/Function	Finish	Options
50	DL2013	626	

Numbers

If you know . . .

. . . then you know

Corbin	Russwin	Description	Corbin	Russwin
880-6	880-6	Single cylinder		DL2013
881-6	881-6	Cylinder x blank		DL2011
883-6	883-6	Classroom		DL2017
885-6	885-6	Double cylinder		DL2012
<hr/>				
621	1413 ^{1/4}	Cylinder x blank		DL3011
622	1413 ^{1/2}	Double cylinder		DL3012
623	1413	Single cylinder		DL3013
625	1413 ^{7/8}	Thumbturn x blank		DL3060
627	1413 ^{3/4}	Classroom		DL3017
<hr/>				
421	1503 ^{1/4}	Cylinder x blank		DL4011
422	1503 ^{1/2}	Double cylinder		DL4012
423	1503	Single cylinder		DL4013
427	1503 ^{3/4}	Classroom		DL4017



Push-Pull Latches Ordering Configuration

Qty	Series/Function	Finish	Options
50	HL13	626	

Numbers

If you know . . .

. . . then you know

Corbin	Russwin	Description	Corbin	Russwin
1850	H10	Exposed screws push side, short pull		HL11
1860	H11	Exposed screws push side, large concave pull		HL12
T1850	H010	Exposed screws pull side, short pull		HL13
T1860	H011	Exposed screws pull side, large concave pull		HL14

Nomenclature Made Easy!
Conversion Chart

Pushbar Exit Devices

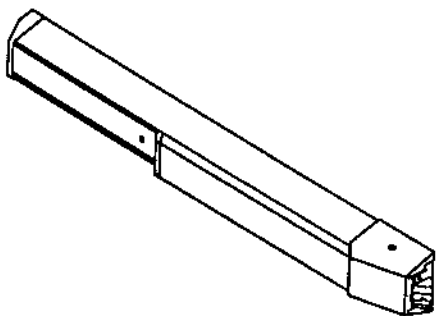

Ordering Configuration

Qty	Series/Function	Trim	Finish	Hand	Options
100	ED9200	N157	626	LHR	M61

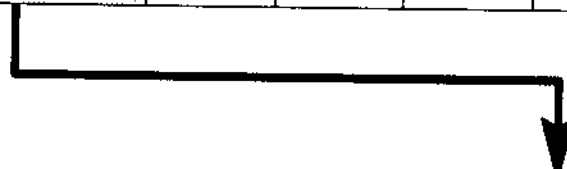

Series/Function Numbers

If you know . . .

. . . then you know

Corbin	Russwin	Description	Corbin	Russwin
39	572	Rim	ED9200	
39DB	572DB	Rim	ED9200DB	
LA39	LA572	1 1/2 Hour Fire Rated Rim	ED9200B	
39U	U572	UL Rim	ED9200A	
LA39EL	LA572EL	1 1/2 Hr. Fire Rated Rim w/Alarm	ED9200B (with option M61)	
LA39ELD	LA572ELD	1 1/2 Hr. Fire Rated Rim w/Delayed Alarm	ED9200B (with option M62)	
39EL	572EL	Rim w/Alarm	ED9200 (with option M61)	
39ELD	572ELD	Rim w/ Delayed Alarm	ED9200 (with option M62)	
49	472	Narrow Stile Rim	ED9200 (with option M60)	
49EL	472EL	Narrow Stile Rim w/Alarm	ED9200 (with options M60 and M61)	
<hr/>				
30	582	Vertical Rod	ED9400	
30U	U582	UL Vertical Rod	ED9400A	
<hr/>				
35	592	Mortise	ED9600	
35DC	592DC	Mortise with Cylinder Dogging	ED9600 (with option M52)	
35L	592L	Mortise (for lever trim)	ED9600L	
35LD	592LD	Mortise, Less Dogging	ED9600 (with option M51)	
35U	U592	UL Mortise	ED9600A	
35UL	U592L	UL Mortise (for lever trim)	ED9600AL	

Exit Devices

Nomenclature Made Easy!
Conversion Chart

Low Profile Pushbar Exit Devices

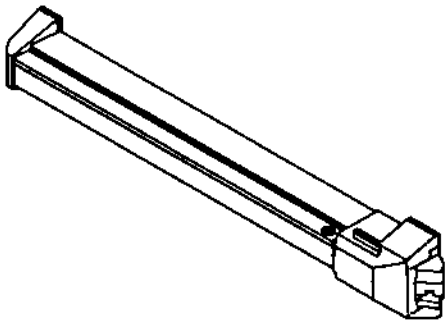

Ordering Configuration

Qty	Series/Function	Trim	Finish	Hand	Options
100	ED8200	P857	689	LHR	M54

Series/Function Numbers

If you know . . .

. . . then you know

Corbin	Ruswin	Description	Corbin	Ruswin
29	372	Rim	ED8200	
LA29	LA372	1 1/2 Hour Fire Rated Rim	ED8200B	
29U	U372	UL Rim	ED8200A	
29EL	372EL	Rim w/Alarm	ED8200 (with option M61)	
29ELD	372ELD	Rim w/Delayed Alarm	ED8200 (with option M62)	
LA29EL	LA372EL	1 1/2 Hr. Fire Rated Rim w/Alarm	ED8200B (with option M61)	
LA29ELD	LA372ELD	1 1/2 Hr. Fire Rated Rim w/Delayed Alarm	ED8200B (with option M62)	
20	382	Vertical Rod	ED8400	
20U	U382	UL Vertical Rod	ED8400A	
25	392	Mortise	ED8600	
25L	392L	Mortise (for lever trim)	ED8600L	
25U	U392	UL Mortise Device	ED8600A	
25UL	U392L	UL Mortise (for lever trim)	ED8600AL	

Nomenclature Made Easy!
Conversion Chart

Pushbar Exit Device Trim

Ordering Configuration

Qty	Series/Function	Trim	Finish	Hand	Options
100	ED9200	A157	626	LHR	M52

Escutcheon Trim Designation

If you know . . .

. . . then you know

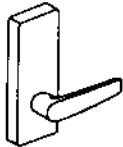
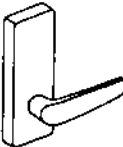
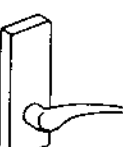
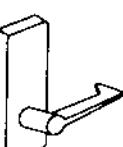
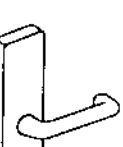

Corbin	Russwin		Corbin Russwin
50DTL x 975L	50DTL x Armstrong		A150
51AL x 975L	51PL x Armstrong		A110
52BL x 975L	53PL x Armstrong		A155
52CL x 975L	53PNL x Armstrong		A157
50DTL x 765L	50DTL x Citation		C150
51AL x 765L	51PL x Citation		C110
52BL x 765L	53PL x Citation		C155
52CL x 765L	53PNL x Citation		C157
50DTL x 760L	50DTL x Dirke		D150
51AL x 760L	51PL x Dirke		D110
52BL x 760L	53PL x Dirke		D155
52CL x 760L	53PNL x Dirke		D157
50DTL x 766L	50DTL x Tornay		E150
51AL x 766L	51PL x Tornay		E110
52BL x 766L	53PL x Tornay		E155
52CL x 766L	53PNL x Tornay		E157
50DTL x 779L3	50DTL x L3 Lustra		L150
51AL x 779L3	51PL x L3 Lustra		L110
52BL x 779L3	53PL x L3 Lustra		L155
52CL x 779L3	53PNL x L3 Lustra		L157

Pushbar Exit Device Trim

Escutcheon Trim Designation

If you know . . .

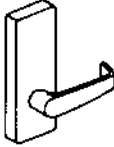
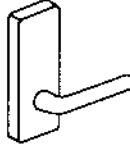

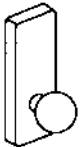
. . . then you know

Corbin	Russwin		Corbin Russwin
50DTL x 977L	50DTL x Newport		N150
51AL x 977L	51PL x Newport		N110
52BL x 977L	53PL x Newport		N155
52CL x 977L	53PNL x Newport		N157
50DTL x 771L3	50DTL x L3 Regis		R150
51AL x 771L3	51PL x L3 Regis		R110
52BL x 771L3	53PL x L3 Regis		R155
52CL x 771L3	53PNL x L3 Regis		R157
50DTK x 865	50DTK x Belmont		B150
51AK x 865	51PK x Belmont		B110
52BK x 865	53PK x Belmont		B155
52CK x 865	53PNK x Belmont		B157
50DTK x 863	50DTK x Ashford		G150
51AK x 863	51PK x Ashford		G110
52BK x 863	53PK x Ashford		G155
52CK x 863	53PNK x Ashford		G157

Rose Trim Designation

If you know . . .

. . . then you know

Corbin	Russwin		Corbin Russwin
5DTL	83DT x Armstrong		A250
5AL	81L x Armstrong		A210
5BL	83L x Armstrong		A255
5CL	83NT x Armstrong		A257
5MDL	93DTL x Armstrong		A2M50
5MAL	91L x Armstrong		A2M10
5MBL	93L x Armstrong		A2M55
5MCL	93NTL x Armstrong		A2M57







Nomenclature Made Easy!
Conversion Chart

Pushbar Exit Device Trim

Rose Trim Designation

If you know . . .

. . . then you know

Corbin	Ruswin		Corbin	Ruswin
7DTL	83DT x Newport		N250	
7AL	81L x Newport		N210	
7BL	83L x Newport		N255	
7CL	83NT x Newport		N257	
7MDL	93DTL x Newport		N2M50	
7MAL	91L x Newport		N2M10	
7MBL	93L x Newport		N2M55	
7MCL	93NTL x Newport		N2M57	
865DTK	83DTK x Belmont			B250
865AK	81K x Belmont		B210	
865BK	83K x Belmont		B255	
865CK	83NTK x Belmont		B257	
865MDK	93DTK x Belmont		B2M50	
865MAK	91K x Belmont		B2M10	
865MBK	93K x Belmont		B2M55	
865MCK	93NTK x Belmont		B2M57	
863DTK	83DTK x Ashford			G250
863AK	81K x Ashford		G210	
863BK	83K x Ashford		G255	
863CK	83NTK x Ashford		G257	
863MDK	93DTK x Ashford		G2M50	
863MAK	91K x Ashford		G2M10	
863MBK	93K x Ashford		G2M55	
863MCK	93NTK x Ashford		G2M57	
31K	31K			G310
32K	33K	G355		
39K	39K	G355 (with option LC)		





Nomenclature Made Easy!
Conversion Chart

Pushbar Exit Device Trim

Plate or Pull Trim Designation

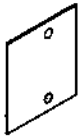
If you know . . .

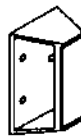
. . . then you know

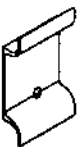



Corbin	Russwin		Corbin Russwin
DTPL 2PL 9PL	DTPL 3PL 9PL		F150 F157 F157 (with option LC)
3DTP 32P 39P	3DTP 33P 39P		P150 P157 P157 (with option LC)
4DTP 42P 49P	4DTP 43P 49P		P250 P257 P257 (with option LC)
62DTP 62P	53DTP 53P		P350 P357
DTP 2P 9P	DTP 3P 9P		P850 P857 P857 (with option LC)

Pushbar Exit Device Trim

Thumbpiece Trim Designation

If you know . . .

. . . then you know

Corbin	Russwin		Corbin	Russwin
4D	508		T150	
4A	518		T110	
4B	538		T155	
4MD	508M		T1M50	
4MA	518M		T1M10	
4MB	538M		T1M55	
6D	507		T250	
6A	517		T210	
6B	537		T255	
6MD	507M		T2M50	
6MA	517M		T2M10	
6MB	537M		T2M55	

Exit Devices

Nomenclature Made Easy!
Conversion Chart

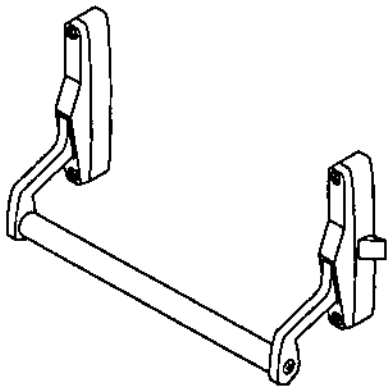

Narrow Stile Crossbar Exit Devices

Ordering Configuration

Qty	Series/Function	Trim	Finish	Hand	Options
100	ED7200	P657	626	LHR	M66



Series/Function Numbers

If you know . . .

. . . then you know

Corbin	Russwin	Description	Corbin Russwin
4726NT	635	Rim	ED7200
4729 ^{1/4}	LT635	Rim	ED7200
4729	635 ^{1/4}	Rim	ED7200
4726NTNH	634	Rim	ED7200 (with option M66)
4729 ^{1/4} NH	LT634	Rim	ED7200 (with option M66)
4161	691	Vertical Rod	ED7400
4162	692	Vertical Rod	ED7400
4163	693	Vertical Rod	ED7400
4168	698	Vertical Rod	ED7400
4161 (Plaza)	691 (Citation)	Vertical Rod	ED7401
4163 (Plaza)	693 (Citation)	Vertical Rod	ED7401
4168 (Plaza)	698 (Citation)	Vertical Rod	ED7401
4126	696	Mortise	ED7600
4126NT	NT696	Mortise	ED7600
4127K	697K	Mortise	ED7600
4127L	697L	Mortise	ED7600
4129	699A	Mortise	ED7600
4126U	U696	3 Hour Mortise	ED7600A
4126NTU	UNT696	3 Hour Mortise	ED7600A
4127KU	U697K	3 Hour Mortise	ED7600A
4127LU	U697L	3 Hour Mortise	ED7600A
4129U	U699A	3 Hour Mortise	ED7600A
4062	CH642	Concealed Vertical Rod	ED7800
4062U	UCH642	3 Hour Concealed Vertical Rod	ED7800A
4065	CH645	Concealed Vertical Rod	ED7800 x O557
4065U	UCH645	3 Hour Concealed Vertical Rod	ED7800A x O557

Nomenclature Made Easy!
Conversion Chart

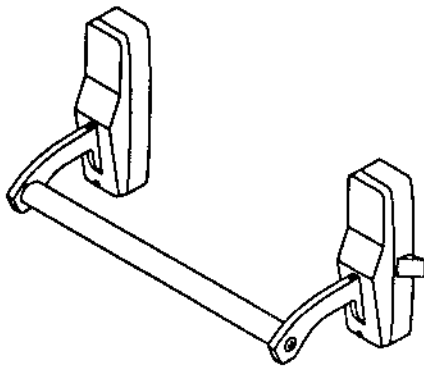

Wide Case Crossbar Exit Devices

Ordering Configuration

Qty	Series/Function	Trim	Finish	Hand	Options
100	ED6400	L255	626	LHR	M65



Series/Function Numbers

If you know . . .

. . . then you know

Corbin	Russwin	Description	Corbin Russwin
3726	736	Rim	ED6200
3726NT	NT736	Rim	ED6200
3727	737	Rim	ED6200
3729	736 ^{1/4}	Rim	ED6200
7729U	U936	3 Hour Rim	ED6200A
7729 ^{1/4} U	U935	3 Hour Rim	ED6257A
3112-73	700-73	Vertical Rod	ED6410 (with option M65)
3114-73	790-73	Vertical Rod	ED6410 (with option M65)
3120-73	H792-73	Vertical Rod	ED6410
3120EO-73	H709-73	Vertical Rod	ED6400
3121-73	791-73	Vertical Rod	ED6457 (with option M65)
3122-73	792-73	Vertical Rod	ED6410 (with option M65)
3122EO-73	709-73	Vertical Rod	ED6400 (with option M65)
3125-73	H798-73	Vertical Rod	ED6410
3128-73	798-73	Vertical Rod	ED6410 (with option M65)
3144-73	H704-73	Vertical Rod	ED6458
3145-73	H708-73	Vertical Rod	ED6410
3147-73	704-73	Vertical Rod	ED6458
3148-73	708-73	Vertical Rod	ED6410 (with option M65)
3149-73	701-73	Vertical Rod	ED6457 (with option M65)
3154-73	H794-73	Vertical Rod	ED6458
3157-73	794-73	Vertical Rod	ED6458
3210U-73	U770-73	3 Hour Vertical Rod	ED6410A
3220EOU-73	U789-73	3 Hour Vertical Rod	ED6400A
3225U-73	U788-73	3 Hour Vertical Rod	ED6410A
3245U-73	U778-73	3 Hour Vertical Rod	ED6410A

Nomenclature Made Easy!
Conversion Chart

Wide Case Crossbar Exit Devices

Series Numbers

If you know . . .

. . . then you know

Corbin	Russwin	Description	Corbin Russwin
3129	799A	Mortise	ED6600
3126	796	Mortise	ED6600
3126NT	NT796	Mortise	ED6600
3127	797	Mortise	ED6600
3129U	U799A	3 Hour Mortise	ED6600A
3126U	U796	3 Hour Mortise	ED6600A
3126NTU	UNT796	3 Hour Mortise	ED6600A
3127U	U797	3 Hour Mortise	ED6600A
3062	CH742	Concealed Vertical Rod	ED6800
3062U	UCH742	3 Hour Concealed Vertical Rod	ED6800A
3068A	CH748A	Concealed Vertical Rod	ED6800 (with trim O155)
3068G	CH748G	Concealed Vertical Rod	ED6800 (with trim O255)
3068K	CH748K	Concealed Vertical Rod	ED6800 (with trim B555)
3063A	CH743A	Concealed Vertical Rod	ED6800 (with trim O156)
3063G	CH743G	Concealed Vertical Rod	ED6800 (with trim O256)
3010K	CH744K	Concealed Vertical Rod	ED6800 (with trim B510)
3061A	CH741A	Concealed Vertical Rod	ED6800 (with trim O157)
3061G	CH741G	Concealed Vertical Rod	ED6800 (with trim O257)
3061K	CH741K	Concealed Vertical Rod	ED6800 (with trim B557)
3062A	CH742A	Concealed Vertical Rod	ED6800 (with trim O150)
3062G	CH742G	Concealed Vertical Rod	ED6800 (with trim O250)
3062K	CH742K	Concealed Vertical Rod	ED6800 (with trim B550)
3068AU	UCH748A	3 Hour Concealed Vertical Rod	ED6800A (with trim O155)
3068GU	UCH748G	3 Hour Concealed Vertical Rod	ED6800A (with trim O255)
3068KU	UCH748K	3 Hour Concealed Vertical Rod	ED6800A (with trim B555)
3010KU	UCH744K	3 Hour Concealed Vertical Rod	ED6800A (with trim B510)
3061AU	UCH741A	3 Hour Concealed Vertical Rod	ED6800A (with trim O157)
3061GU	UCH741G	3 Hour Concealed Vertical Rod	ED6800A (with trim O257)
3061KU	UCH741K	3 Hour Concealed Vertical Rod	ED6800A (with trim B557)
3062AU	UCH742A	3 Hour Concealed Vertical Rod	ED6800A (with trim O150)
3062GU	UCH742G	3 Hour Concealed Vertical Rod	ED6800A (with trim O250)
3062KU	UCH742K	3 Hour Concealed Vertical Rod	ED6800A (with trim B550)

Nomenclature Made Easy!
Conversion Chart

Crossbar Exit Device Trim

Ordering Configuration

Qty	Series/Function	Trim	Finish	Hand	Options
100	ED6200	A355	626	LHR	M53

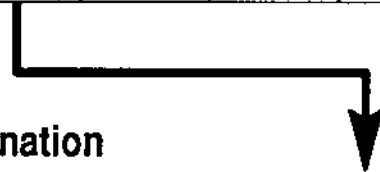

Escutcheon Trim Designation

If you know . . .

. . . then you know

Corbin	Russwin		Corbin Russwin
37B x 975L 37 x 975L	Armstrong x B888L Armstrong x 888L		A310 A355
037DU x 975L 37UB x 975L 37U x 975L	Armstrong x DU888L Armstrong x UB888L Armstrong x U888L		A450 A410 A455
037D x 975L 037MB x 975L 037M x 975L	Armstrong x DU888LN Armstrong x B888LN Armstrong x 888LN		A4M50 A4M10 A4M55
037D x 765L 37B x 765L 37 x 765L	Citation x D888L Citation x B888L Citation x 888L		C255 C210 C255
037DU x 765L 37UB x 765L 37U x 765L	Citation x DU888L Citation x UB888L Citation x U888L		C350 C310 C355
037D x 765L 037MB x 765L 037M x 765L	Citation x DU888LN Citation x B888LN Citation x 888LN		C3M50 C3M10 C3M55

Crossbar Exit Device Trim

Escutcheon Trim Designation

If you know . . .

. . . then you know

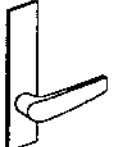
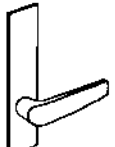
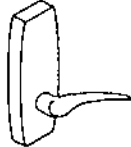
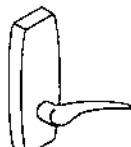
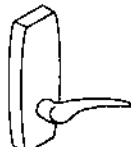
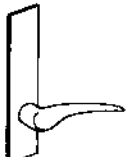
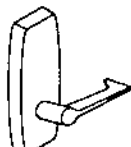
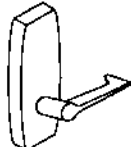
Corbin	Russwin		Corbin Russwin
76568L 76561L	423C Citation 423A Citation		C455 C457
75DL x 765L 75NCL x 765L 75L x 765L	426DL Citation 426NCL Citation 426L Citation		C4M50 C4M10 C4M55
037D x 760L 37B x 760L 37 x 760L	Dirke x D888L Dirke x B888L Dirke x 888L		D250 D210 D255
037DU x 760L 37UB x 760L 37U x 760L	Dirke x DU888L Dirke x UB888L Dirke x U888L		D350 D310 D355
037D x 760L 037MB x 760L 037M x 760L	Dirke x DU888LN Dirke x B888LN Dirke x 888LN		D3M50 D3M10 D3M55
76068L 76061L	423C Dirke 423A Dirke		D455 D457
037D x 766L 37B x 766L 37 x 766L	Tornay x D888L Tornay x B888L Tornay x 888L		E250 E210 E255
037DU x 766L 37UB x 766L 37U x 766L	Tornay x DU888L Tornay x UB888L Tornay x U888L		E350 E310 E355

Nomenclature Made Easy!
Conversion Chart

Crossbar Exit Device Trim Escutcheon Trim Designation

If you know . . .



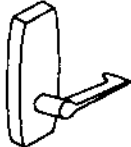
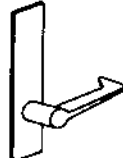
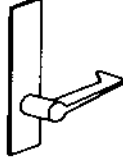
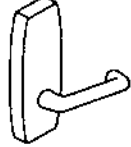
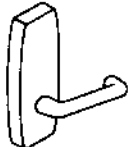
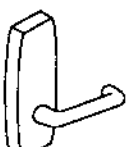
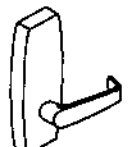
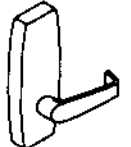

. . . then you know

Corbin	Russwin		Corbin Russwin
037D x 766L 037MB x 766L 037M x 766L	Tornay x DU888LN Tornay x B888LN Tornay x 888LN		E3M50 E3M10 E3M55
76668L 76661L	423C Tornay 423A Tornay		E455 E457
75DL x 766L 75NCL x 766L 75L x 766L	426DL x Tornay 426DL x Tornay 426L x Tornay		E4M50 E4M10 E4M55
037D x 779L 37B x 779L 37 x 779L	Lustra x D888L Lustra x B888L Lustra x 888L		L250 L210 L255
037DU x 779L 37UB x 779L 37U x 779L	Lustra x DU888L Lustra x UB888L Lustra x U888L		L350 L310 L355
037D x 779L 037MB x 779L 037M x 779L	Lustra x DU888LN Lustra x B888LN Lustra x 888LN		L3M50 L3M10 L3M55
037D x 977L 37B x 977L 37 x 977L	Newport x D888L Newport x B888L Newport x 888L		N350 N310 N355
037DU x 977L 37UB x 977L 37U x 977L	Newport x DU888L Newport x UB888L Newport x U888L		N450 N410 N455

Crossbar Exit Device Trim Escutcheon Trim Designation

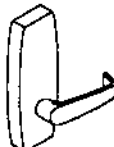
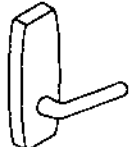
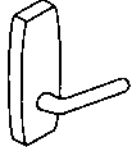
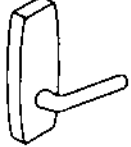
If you know . . .

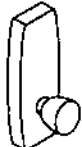
. . . then you know







Corbin	Russwin		Corbin Russwin
037D x 977L 037MB x 977L 037M x 977L	Newport x DU888LN Newport x B888LN Newport x 888LN		N4M50 N4M10 N4M55
037D x 771L 37B x 771L 37 x 771L	Regis x D888L Regis x B888L Regis x 888L		R250 R210 R255
037DU x 771L 37UB x 771L 37U x 771L	Regis x DU888L Regis x UB888L Regis x U888L		R350 R310 R355
037DU x 771L 037MB x 771L 037M x 771L	Regis x DU888LN Regis x B888LN Regis x 888LN		R3M50 R3M10 R3M55
027D x 865 27B x 865 27 x 865	Belmont x D778N Belmont x B777 Belmont x 777		B350 B310 B355
027DU x 865 27UB x 865 27U x 865 27UR x 865	Belmont x DU777 Belmont x BU777 Belmont x U777 Belmont x UR777		B450 B410 B455 B457
027D x 865 027MB x 865 027M x 865	Belmont x D778N Belmont x B778N Belmont x 778N		B4M50 B4M10 B4M55
3062K x 865 3010K x 865 3068K x 865 3061K x 865	Belmont x CH742K Belmont x CH744K Belmont x CH748K Belmont x CH741K		B550 B510 B555 B557

Nomenclature Made Easy!
Conversion Chart

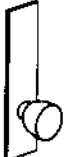
Crossbar Exit Device Trim Escutcheon Trim Designation

If you know . . .

. . . then you know





Corbin	Russwin		Corbin Russwin
75DK x 865 75NCK x 865 75K x 865	425DK Belmont 425NCK Belmont 425K Belmont		B5M50 B5M10 B5M55
027D x 863 27B x 863 27 x 863	Ashford x D778N Ashford x B777 Ashford x 777		G450 G410 G455
027DU x 863 27UB x 863 27U x 863 27UR x 863	Ashford x DU777 Ashford x BU777 Ashford x U777 Ashford x UR777		G550 G510 G555 G557
027D x 863 027MB x 863 027M x 863	Ashford x D778N Ashford x B778N Ashford x 778N		G5M50 G5M10 G5M55
3062K x 863 3010K x 863 3068K x 863 3061K x 863	Ashford x CH742K Ashford x CH744K Ashford x CH748K Ashford x CH741K		G650 G610 G655 G657
75DK x 863 75NCK x 863 75K x 863	425DK Ashford 425NCK Ashford 425K Ashford		G6M50 G6M10 G6M55

Crossbar Exit Device Trim

Thumbpiece Trim Designation

If you know . . .

. . . then you know

Corbin	Russwin		Corbin Russwin
70A-DNT	DNT 8416 Rockford		T350
70A-NC	NC 8415 Rockford		T310
70A	8415 Rockford		T355
70A-NT	NT 8415 Rockford		T357
70AU-DNT	DNTU 8416 Rockford		T750
70AU-NC	NCU 8415 Rockford		T710
70AU	U8415 Rockford		T755
70AU-NT	NTU 8415 Rockford		T757
70A-DNT	DNT 8416 Rockford		T7M50
70MA-NC	NC 8416 Rockford		T7M10
70MA	8416 Rockford		T7M55
70MA-NT	NT 8416 Rockford		T7M57
34A-DNT	DNT 8426 Ronde		T550
34A-NC	NC 8425 Ronde		T510
34A	8425 Ronde		T555
34A-NT	NT 8425 Ronde		T557
34AU-DNT	DNT 8426 Ronde		T950
34AU-NC	NCU 8425 Ronde		T910
34AU	U8425 Ronde		T955
34AU-NT	NTU 8425 Ronde		T957





Nomenclature Made Easy!
Conversion Chart

Crossbar Exit Device Trim

Thumbpiece Trim Designation

If you know . . .

















. . . then you know

Corbin	Russwin		Corbin Russwin
34A-DNT	DNT 8426 Ronde		T9M50
34MA-NC	NC 8426 Ronde		T9M10
34MA	U8426 Ronde		T9M55
34MA-NT	NT8426 Ronde		T9M57
75DNTA	DNT 4318 Modera		T11M50
75NCA	NC 4318 Modera		T11M10
75A	4318 Modera		T11M55
75NTA	NT4318 Modera		T11M57
70G-DNT	DNT 7416 Rockford		T450
70G-NC	NC 7415 Rockford		T410
70G	7415 Rockford		T455
70G-NT	NT 7415 Rockford		T457
70GU-DNT	DNTU 7416 Rockford		T850
70GU-NC	NCU 7415 Rockford		T810
70GU	U7415 Rockford		T855
70GU-NT	NTU 7415 Rockford		T857
70G-DNT	DNT 7416 Rockford		T8M50
70MG-NC	NC 7416 Rockford		T8M10
70MG	7416 Rockford		T8M55
70MG-NT	NT 7416 Rockford		T8M57

Crossbar Exit Device Trim Thumbpiece Trim Designation

If you know . . .

. . . then you know

Corbin	Russwin		Corbin Russwin
34G-DNT	DNT 7426 Ronde		T650
34G-NC	NC 7425 Ronde		T610
34G	7425 Ronde		T655
34G-NT	NT 7425 Ronde		T657
34GU-DNT	DNT 7426 Ronde		T1050
34GU-NC	NCU 7425 Ronde		T1010
34GU	U7425 Ronde		T1055
34GU-NT	NTU 7425 Ronde		T1057
34G-DNT	DNT 7426 Ronde		T10M50
34MG-NC	NC 7426 Ronde		T10M10
34MG	7426 Ronde		T10M55
34MG-NT	NT 7426 Ronde		T10M57
75DNTG	DNT 4317 Modera		T12M50
75NCG	NC 4317 Modera		T12M10
75G	4317 Modera		T12M55
75NTG	NT 4317 Modera		T12M57





Nomenclature Made Easy!
Conversion Chart

Crossbar Exit Device Trim

Operator Trim Designation

If you know . . .

. . . then you know

Corbin	Russwin		Corbin Russwin
3062A	CH742A		O150
3068A	CH748A		O155
3063A	CH743A		O156
3061A	CH741A		O157
68PA	428A Phillip		O355
63PA	428B Phillip		O356
61PA	428C Phillip		O357
3062G	CH742G		O250
3068G	CH748G		O255
3063G	CH743G		O256
3061G	CH741G		O257
68PO	422A Phillip		O455
63PO	422B Phillip		O456
61PO	422C Phillip		O457





Nomenclature Made Easy!
Conversion Chart

Crossbar Exit Device Trim

Pull or Operator Trim Designation

If you know . . .

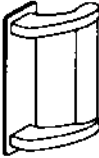
. . . then you know

Corbin	Russwin		Corbin Russwin
47DNTA 47NTA	DNT 4218 Rockford NT 4218 Rockford		P450 P457
47DNTG 47NTG	DNT 4217 Rockford NT 4217 Rockford		P550 P557
49DNT 49NT	DNT 422 Rockford NT 422 Rockford		P650 P657
48	917 Rockford		P757
406F44	406F85		O557

Nomenclature Made Easy!
Conversion Chart

Electromechanical Mortise Wide Case Crossbar Exit Devices

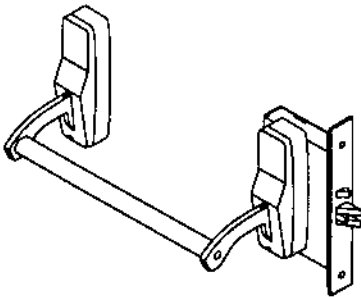

Ordering Configuration

Qty	Series/Function	Trim	Finish	Hand	Options
100	ED66901	L255	626	LHR	M50

Series/Function Numbers

If you know . . .

. . . then you know

Corbin	Russwin	Description	Corbin	Russwin
3126UTL	TLU796	Electro-mechanical Mortise	ED66901	
3126UT	TU796	Electro-mechanical Mortise	ED66902	
3127UTL	TLU797	Electro-mechanical Mortise	ED66903	
3127UT	TU797	Electro-mechanical Mortise	ED66904	

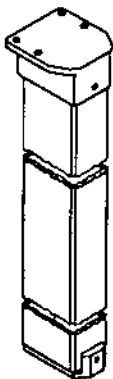

Mullions

Ordering Configuration

Qty	Number	Finish
100	508	690

Numbers

If you know . . .

. . . then you know

Corbin	Russwin	Description	Corbin	Russwin
U0569	U0569	7'2" Fire Rated Removable Mullion	507	
U0570	U0570	8' Fire Rated Removable Mullion	508	
0570	0570	10' Removable Mullion	510	

Nomenclature Made Easy!

Numbers

If you know then you know
OLD CORBIN OR RUSSWIN	CORBIN RUSSWIN
1-1/2C 7P	1000-138-A93-7
1-1/2J	1000-138-A04
1-1/2J 7P	1000-138-A04-7
D 1-1/2	1400-138
MR 1-1/2	1060-138-A62
T 1-1/2C	1300-138-A93
TP 1-1/2C	1303-138-A93
W 1-1/2	1010-138-A02
W 1-1/2A	1010-138-A03
W 1-1/2C	1010-138-A93
2	1000-112-A02
2 7P	1000-112-A02-7
2A	1000-112-A03
2A 7P	1000-112-A03-7
2B	1000-112-A05
2B 7P	1000-112-A05-7
2J	1000-112-A04
2J 7P	1000-112-A04-7
MR 2	1060-112-A62
W 2	1010-112-A02
3	1000-134-A02
3 7P	1000-134-A02-7
3A	1000-134-A03
3A 7P	1000-134-A03-7
3B	1000-134-A05
3B 7P	1000-134-A05-7
3J	1000-134-A04
3J 7P	1000-134-A04-7
MR 3	1060-134-A62
W 3	1010-134-A02
4	1000-200-A02
4 7P	1000-200-A02-7
4A	1000-200-A03
4A 7P	1000-200-A03-7
4B	1000-200-A05
4B 7P	1000-200-A05-7
4J	1000-200-A04
4J 7P	1000-200-A04-7
MR 4	1060-200-A62
W 4	1010-200-A02
5	1000-214-A02
5 7P	1000-214-A02-7
5A	1000-214-A03
5A 7P	1000-214-A03-7
5B	1000-214-A05
5B 7P	1000-214-A05-7
MR 5	1060-214-A62
W 5	1010-214-A02
6	1000-212-A02
6 7P	1000-212-A02-7
6A	1000-212-A03
6A 7P	1000-212-A03-7

Cylinders

If you know then you know
OLD CORBIN OR RUSSWIN	CORBIN RUSSWIN
6B	1000-212-A05
6B 7P	1000-212-A05-7
MR 6	1060-212-A62
W 6	1010-212-A02
13	1000-234-A02
13 7P	1000-234-A02-7
13A	1000-234-A03
13A 7P	1000-234-A03-7
13B	1000-234-A05
13B 7P	1000-234-A05-7
MR 13	1060-234-A62
W 13	1010-234-A02
14	1000-300-A02
14 7P	1000-300-A02-7
14A	1000-300-A03
14A 7P	1000-300-A03-7
14B	1000-300-A05
14B 7P	1000-300-A05-7
MR 14	1060-300-A62
15	1000-314-A02
15A	1000-314-A03
15B	1000-314-A05
16	1000-312-A02
16A	1000-312-A03
16B	1000-312-A05
17	1000-334-A02
17A	1000-334-A03
17B	1000-334-A05
20	1060-100-A63-5
20 T	1060-100-A64-5
20-1/2	1060-118-A63
20-1/2C	discontinued
20-1/2T	1060-118-A64
21	1060-114-A63
21C	discontinued
21 T	1060-114-A64
21-1/2	1060-138-A63
21-1/2C	discontinued
21-1/2T	1060-138-A64
22	1060-112-A63
22C	discontinued
22T	1060-112-A64
23	1060-134-A63
23T	1060-134-A64
24	1060-200-A63
24T	1060-200-A64
25	1060-214-A63
25T	1060-214-A64
26	1060-212-A63
26T	1060-212-A64
29	1060-234-A63
29T	1060-234-A64

If you know then you know
OLD CORBIN OR RUSSWIN	CORBIN RUSSWIN
WK48	2010-052
WK51	2011-042
52 1-1/8"	1400-118
52 1-1/4"	1400-114
52 1-3/8"	1400-138
53 1-1/8"	1000-118-A93
53 1-1/4"	1000-114-A93
53 1-1/4" 7P	1000-114-A93-7
53 1-3/8"	1000-138-A93
53 1-3/8" 7P	1000-138-A93-7
53-1/2 1-1/8"	discontinued
53-1/2 1-1/4"	discontinued
53-1/2 1-3/8"	discontinued
53-1/2 1-1/2"	discontinued
63 1-1/8"	1000-118-A93
63 1-1/4"	1000-114-A93
63 1-1/4" 7P	1000-114-A93-7
63 1-3/8"	1000-138-A93
63 1-3/8" 7P	1000-138-A93-7
W 63 1-1/8"	1010-118-A93
W 63 1-1/4"	1010-114-A93
W 63 1-3/8"	1010-138-A93
63-1/2 1-1/8"	discontinued
63-1/2 1-1/4"	discontinued
63-1/2 1-3/8"	discontinued
63-1/2 1-1/2"	discontinued
67 1-1/8"	1303-118-A93
67 1-1/4"	1303-114-A93
67 1-3/8"	1303-138-A93
69 1-1/8"	1300-118-A93
69 1-1/4"	1300-114-A93
69 1-3/8"	1300-138-A93
70	discontinued
70-1/2	discontinued
71	discontinued
71-1/2	discontinued
83 1-1/4"	1080-114-A93
83 1-3/8"	1080-138-A93
83 1-1/2"	1080-112-A93
83 1-1/2" 7P	1080-112-A93-7
W 83 1-1/4"	1090-114-A93
W 83 1-3/8"	1090-138-A93
W 83 1-1/2"	1090-112-A93
W 93 1-1/4"	1012-114-A93
100	1200-100-A02
100-1/2	1200-118-A02
101	1200-114-A02
101 7P	1200-114-A02-7
101-1/2	1200-138-A02
101-1/2 7P	1200-138-A02-7
102	1200-112-A02
102 7P	1200-112-A02-7

Nomenclature Made Easy!
Conversion Chart

Cylinders

Numbers

If you know then you know

OLD CORBIN OR RUSSWIN	CORBIN RUSSWIN
110	1000-100-A01-5
MR 110	1060-100-A65-5
110-1/2	1000-118-A01
MR 110-1/2	1060-118-A65
W 110-1/2	1010-118-A01
111	1000-114-A01
111 7P	1000-114-A01-7
111 HM	1001-114-A01
111 HMP	1201-114-A01
MR 111	1060-114-A65
W 111	1010-114-A01
W 111BO	1012-114-A01
W 111HM	1011-114-A01
111-1/2	1000-138-A01
111-1/2 7P	1000-138-A01-7
MR 111-1/2	1060-138-A65
W 111-1/2	1010-138-A01
112	1000-112-A01
112 7P	1000-112-A01-7
MR 1-1/2"	1060-112-A65
W 1-1/2"	1010-112-A01
113	1000-134-A01
113 7P	1000-134-A01-7
MR 113	1060-134-A65
114	1000-200-A01
114 7P	1000-200-A01-7
MR 1-1/4"	1060-200-A65
115	1000-214-A01
115 7P	1000-214-A01-7
MR 115	1060-214-A65
116	1000-212-A01
116 7P	1000-212-A01-7
MR 116	1060-212-A65
195-0	1300-100-A02
195-0-1/2	1300-118-A02
195-1	1300-114-A02
211	3000-200
211 7P	3000-200-7
211 T	3000-200V
211 T 7P	3000-200V-7
211-1/2	3060-200
211-1/2T	3060-200V
253 1"	1000-100-A02-5
253 1-1/8"	1000-118-A02
253 1-1/4"	1000-114-A02
253 1-1/4" 7P	1000-114-A02-7
253 1-3/8"	1000-138-A02
253 1-3/8" 7P	1000-138-A02-7
253 1-1/2"	1000-112-A02
253 1-1/2" 7P	1000-112-A02-7
253 1-3/4"	1000-134-A02
253 1-3/4" 7P	1000-134-A02-7

If you know then you know

OLD CORBIN OR RUSSWIN	CORBIN RUSSWIN
253 2"	1000-200-A02
253 2" 7P	1000-200-A02-7
253 2-1/4"	1000-214-A02
253 2-1/2"	1000-212-A02
253 2-3/4"	1000-234-A02
253 3"	1000-300-A02
253 A 1"	1000-100-A03-5
253 A 1-1/8"	1000-118-A03
253 A 1-1/4"	1000-114-A03
253 A 1-1/4" 7P	1000-114-A03-7
253 A 1-3/8"	1000-138-A03
253 A 1-3/8" 7P	1000-138-A03-7
253 A 1-1/2"	1000-112-A03
253 A 1-1/2" 7P	1000-112-A03-7
253 A 1-3/4"	1000-134-A03
253 A 1-3/4" 7P	1000-134-A03-7
253 A 2"	1000-200-A03
253 A 2" 7P	1000-200-A03-7
253 A 2-1/4"	1000-214-A03
253 A 2-1/2"	1000-212-A03
253 A 2-3/4"	1000-234-A03
253 A 3"	1000-300-A03
253 B 1"	1000-100-A05-5
253 B 1-1/8"	1000-118-A05
253 B 1-1/4"	1000-114-A05
253 B 1-1/4" 7P	1000-114-A05-7
253 B 1-3/8"	1000-138-A05
253 B 1-3/8" 7P	1000-138-A05-7
253 B 1-1/2"	1000-112-A05
253 B 1-1/2" 7P	1000-112-A05-7
253 B 1-3/4"	1000-134-A05
253 B 1-3/4" 7P	1000-134-A05-7
253 B 2"	1000-200-A05
253 B 2" 7P	1000-200-A05-7
253 B 2-1/4"	1000-214-A05
253 B 2-1/2"	1000-212-A05
253 B 2-3/4"	1000-234-A05
253 B 3"	1000-300-A05
253 FE	1006-118-A02
253-1/4 1"	1000-100-A01-5
253-1/4 1-1/8"	1000-118-A01
253-1/4 1-1/4"	1000-114-A01
253-1/4 1-1/4" 7P	1000-114-A01-7
253-1/4 1-3/8"	1000-138-A01
253-1/4 1-3/8" 7P	1000-138-A01-7
253-1/4 1-1/2"	1000-112-A01
253-1/4 1-1/2" 7P	1000-112-A01-7
253-1/4 1-3/4"	1000-134-A01
253-1/4 1-3/4" 7P	1000-134-A01-7
253-1/4 2"	1000-200-A01
253-1/4 2" 7P	1000-200-A01-7
253-1/4 2-1/4"	1000-214-A01

If you know then you know

OLD CORBIN OR RUSSWIN	CORBIN RUSSWIN
253-1/4 2-1/2"	1000-212-A01
253-1/4 2-3/4"	1000-234-A01
253-1/4 3"	1000-300-A01
253-1/4H	1001-114-A01
253-1/2 1"	1060-100-A63-5
253-1/2 1" x 1A	1060-100-A62-5
253-1/2 1" x 11A	1060-100-A65-5
253-1/2 1-1/8"	1060-118-A63
253-1/2 1-1/8" x 1A	1060-118-A62
253-1/2 1-1/8" x 11A	1060-118-A65
253-1/2 1-1/4"	1060-114-A63
253-1/2 1-1/4" x 1A	1060-114-A62
253-1/2 1-1/4" x 11A	1060-114-A65
253-1/2 1-3/8"	1060-138-A63
253-1/2 1-3/8" x 1A	1060-138-A62
253-1/2 1-3/8" x 11A	1060-138-A65
253-1/2 1-1/2"	1060-112-A63
253-1/2 1-1/2" x 1A	1060-112-A62
253-1/2 1-1/2" x 11A	1060-112-A65
253-1/2 1-3/4"	1060-134-A63
253-1/2 1-3/4" x 1A	1060-134-A62
253-1/2 1-3/4" x 11A	1060-134-A65
253-1/2 2"	1060-200-A63
253-1/2 2" x 1A	1060-200-A62
253-1/2 2" x 11A	1060-200-A65
253-1/2 2-1/4"	1060-214-A63
253-1/2 2-1/4" x 1A	1060-214-A62
253-1/2 2-1/4" x 11A	1060-214-A65
253-1/2 2-1/2"	1060-212-A63
253-1/2 2-1/2" x 1A	1060-212-A62
253-1/2 2-1/2" x 11A	1060-212-A65
253-1/2 2-3/4"	1060-234-A63
253-1/2 2-3/4" x 1A	1060-234-A62
253-1/2 2-3/4" x 11A	1060-234-A65
253-1/2 3"	1060-300-A63
253-1/2 3" x 1A	1060-300-A62
253-1/2 3" x 11A	1060-300-A65
263 1-1/8"	1000-118-A04
263-1/2 1"	1060-100-A64-5
263-1/2 1-1/8"	1060-118-A64
263-1/2 1-1/4"	1060-114-A64
263-1/2 1-3/8"	1060-138-A64
263-1/2 1-1/2"	1060-112-A64
263-1/2 1-3/4"	1060-134-A64
263-1/2 2"	1060-200-A64
263-1/2 2-1/4"	1060-214-A64
263-1/2 2-1/2"	1060-212-A64
263-1/2 2-3/4"	1060-234-A64
263-1/2 3"	1060-300-A64
264 1"	1300-100-A02
264 1-1/8"	1300-118-A02
264 1-1/4"	1300-114-A02

Nomenclature Made Easy!
Conversion Chart

Numbers

If you know then you know
OLD CORBIN OR RUSSWIN	CORBIN RUSSWIN
264-1/4 1"	discontinued
264-1/4 1-1/8"	discontinued
264-1/4 1-1/4"	discontinued
281	3080-178
281 7P	3080-178-7
283 1-1/4"	1080-114-A02
283 1-3/8"	1080-138-A02
283 1-1/2"	1080-112-A02
283 1-1/2" 7P	1080-112-A02-7
283 1-3/4"	1080-134-A02
283 1-3/4" 7P	1080-134-A02-7
283 A 1-1/4"	1080-114-A03
283 A 1-3/8"	1080-138-A03
283 A 1-1/2"	1080-112-A03
283 A 1-1/2" 7P	1080-112-A03-7
283 A 1-3/4"	1080-134-A03
283 A 1-3/4" 7P	1080-134-A03-7
283 B 1-1/4"	1080-114-A05
283 B 1-3/8"	1080-138-A05
283 B 1-1/2"	1080-112-A05
283 B 1-1/2" 7P	1080-112-A05-7
283 B 1-3/4"	1080-134-A05
283 B 1-3/4" 7P	1080-134-A05-7
283 J 1-1/4"	1080-114-A04
283 J 1-3/8"	1080-138-A04
283 J 1-1/2"	1080-112-A04
283 J 1-1/2" 7P	1080-112-A04-7
283 J 1-3/4"	1080-134-A04
283 J 1-3/4" 7P	1080-134-A04-7
P283	8000
P283 7P	8000-7
P283HC	8001-042
283-1/4 1-1/4"	1080-114-A01
283-1/4 1-3/8"	1080-138-A01
283-1/4 1-1/2"	1080-112-A01
283-1/4 1-1/2" 7P	1080-112-A01-7
283-1/4 1-3/4"	1080-134-A01
283-1/4 1-3/4" 7P	1080-134-A01-7
283-1/4 H	1081-138-A01
460-1/2FH	2061-052
460-1/2R	2060-052
471AR	4200-002-A47
571AR	4200-002-A47
800	8000
800 7P	8000-7
800HC	8001-042
W 800	8010
W 800H	8011-042
AR 848	4200-002-A47
ARH 848	4200-003-A47
1113	1000-234-A01
1113 7P	1000-234-A01-7

Cylinders

If you know then you know
OLD CORBIN OR RUSSWIN	CORBIN RUSSWIN
MR1113	1060-234-A65
1114	1000-300-A01
1114 7P	1000-300-A01-7
MR1114	1060-300-A65
1191	3000-200
1191T	3000-200V
1195-0	discontinued
1195-0-1/2	discontinued
1195-1	discontinued
1291	3000-200
1291 7P	3000-200-7
1291T	3000-200V
1291T 7P	3000-200V-7
W1291	3010-200
W1291T	3010-200V
2291	3060-200
2291T	3060-200V
2471AR	4200-003-A47
2571AR	4200-003-A47
S-4542	3000-A38-5
S-4542 x S4748	3000-A39-5
5211	3000-200
5211 7P	3000-200-7
5211 T	3000-200V
5211 T 7P	3000-200V-7
W5211	3010-200
W5211T	3010-200V
5211-1/2	3060-200
5211-1/2T	3060-200V
5253 1"	1000-100-A02-5
5253 1-1/8"	1000-118-A02
5253 1-1/4"	1000-114-A02
5253 1-1/4" 7P	1000-114-A02-7
5253 1-3/8"	1000-138-A02
5253 1-3/8" 7P	1000-138-A02-7
5253 1-1/2"	1000-112-A02
5253 1-1/2" 7P	1000-112-A02-7
5253 1-3/4"	1000-134-A02
5253 1-3/4" 7P	1000-134-A02-7
5253 2"	1000-200-A02
5253 2" 7P	1000-200-A02-7
5253 2-1/4"	1000-214-A02
5253 2-1/4" 7P	1000-214-A02-7
5253 2-1/2"	1000-212-A02
5253 2-1/2" 7P	1000-212-A02-7
5253 2-3/4"	1000-234-A02
5253 2-3/4" 7P	1000-234-A02-7
5253 3"	1000-300-A02
5253 3" 7P	1000-300-A02-7
5253 3-1/4"	1000-314-A02
5253 3-1/2"	1000-312-A02
5253 3-3/4"	1000-334-A02

If you know then you know
OLD CORBIN OR RUSSWIN	CORBIN RUSSWIN
5253 A 1"	1000-100-A03-5
5253 A 1-1/8"	1000-118-A03
5253 A 1-1/4"	1000-114-A03
5253 A 1-1/4" 7P	1000-114-A03-7
5253 A 1-3/8"	1000-138-A03
5253 A 1-3/8" 7P	1000-138-A03-7
5253 A 1-1/2"	1000-112-A03
5253 A 1-1/2" 7P	1000-112-A03-7
5253 A 1-3/4"	1000-134-A03
5253 A 1-3/4" 7P	1000-134-A03-7
5253 A 2"	1000-200-A03
5253 A 2" 7P	1000-200-A03-7
5253 A 2-1/4"	1000-214-A03
5253 A 2-1/4" 7P	1000-214-A03-7
5253 A 2-1/2"	1000-212-A03
5253 A 2-1/2" 7P	1000-212-A03-7
5253 A 2-3/4"	1000-234-A03
5253 A 2-3/4" 7P	1000-234-A03-7
5253 A 3"	1000-300-A03
5253 A 3" 7P	1000-300-A03-7
5253 A 3-1/4"	1000-314-A03
5253 A 3-1/2"	1000-312-A03
5253 A 3-3/4"	1000-334-A03
5253 B 1"	1000-100-A05-5
5253 B 1-1/8"	1000-118-A05
5253 B 1-1/4"	1000-114-A05
5253 B 1-1/4" 7P	1000-114-A05-7
5253 B 1-3/8"	1000-138-A05
5253 B 1-3/8" 7P	1000-138-A05-7
5253 B 1-1/2"	1000-112-A05
5253 B 1-1/2" 7P	1000-112-A05-7
5253 B 1-3/4"	1000-134-A05
5253 B 1-3/4" 7P	1000-134-A05-7
5253 B 2"	1000-200-A05
5253 B 2" 7P	1000-200-A05-7
5253 B 2-1/4"	1000-214-A05
5253 B 2-1/4" 7P	1000-214-A05-7
5253 B 2-1/2"	1000-212-A05
5253 B 2-1/2" 7P	1000-212-A05-7
5253 B 2-3/4"	1000-234-A05
5253 B 2-3/4" 7P	1000-234-A05-7
5253 B 3"	1000-300-A05
5253 B 3" 7P	1000-300-A05-7
5253 B 3-1/4"	1000-314-A05
5253 B 3-1/2"	1000-312-A05
5253 B 3-3/4"	1000-334-A05
5253 FE	1006-118-A02
5253 P 1-1/8"	1200-118-A02
5253 P 1-1/4"	1200-114-A02
5253 P 1-1/4" 7P	1200-114-A02-7
W5253 1-1/8"	1010-118-A02
W5253 1-1/4"	1010-114-A02

Nomenclature Made Easy! Conversion Chart

Numbers

If you know ... then you know

OLD CORBIN OR RUSSWIN	CORBIN RUSSWIN
W5253 1-3/8"	1010-138-A02
W5253 1-1/2"	1010-112-A02
W5253 1-3/4"	1010-134-A02
W5253 2"	1010-200-A02
W5253 2-1/4"	1010-214-A02
W5253 2-1/2"	1010-212-A02
W5253 2-3/4"	1010-234-A02
W5253 A 1-1/8"	1010-118-A03
W5253 A 1-1/4"	1010-114-A03
W5253 A 1-3/8"	1010-138-A03
W5253 B 1-1/8"	1010-118-A05
W5253 B 1-1/4"	1010-114-A05
W5253 J 1-1/8"	1010-118-A04
5253-1/4 1"	1000-100-A01-5
5253-1/4 1-1/8"	1000-118-A01
5253-1/4 1-1/4"	1000-114-A01
5253-1/4 1-1/4" 7P	1000-114-A01-7
5253-1/4 1-3/8"	1000-138-A01
5253-1/4 1-3/8" 7P	1000-138-A01-7
5253-1/4 1-1/2"	1000-112-A01
5253-1/4 1-1/2" 7P	1000-112-A01-7
5253-1/4 1-3/4"	1000-134-A01
5253-1/4 1-3/4" 7P	1000-134-A01-7
5253-1/4 2"	1000-200-A01
5253-1/4 2" 7P	1000-200-A01-7
5253-1/4 2-1/4"	1000-214-A01
5253-1/4 2-1/4" 7P	1000-214-A01-7
5253-1/4 2-1/2"	1000-212-A01
5253-1/4 2-1/2" 7P	1000-212-A01-7
5253-1/4 2-3/4"	1000-234-A01
5253-1/4 2-3/4" 7P	1000-234-A01-7
5253-1/4 3"	1000-300-A01
5253-1/4 3" 7P	1000-300-A01-7
5253-1/4H	1001-114-A01
5253-1/4HP	1201-114-A01
5253-1/4P 1-1/4"	1200-114-A01
5253-1/4P 1-1/4" 7P	1200-114-A01-7
5253-1/4P 1-1/8"	1200-118-A01
W5253-1/4 1-1/8"	1010-118-A01
W5253-1/4 1-1/4"	1010-114-A01
W5253-1/4 1-3/8"	1010-138-A01
W5253-1/4 1-1/2"	1010-112-A01
W5253-1/4H	1011-114-A01
5253-1/2 1"	1060-100-A63-5
5253-1/2 1" x 1A	1060-100-A62-5
5253-1/2 1" x 11A	1060-100-A65-5
5253-1/2 1-1/8"	1060-118-A63
5253-1/2 1-1/8" x 1A	1060-118-A62
5253-1/2 1-1/8" x 11A	1060-118-A65
5253-1/2 1-1/4"	1060-114-A63
5253-1/2 1-1/4" x 1A	1060-114-A62
5253-1/2 1-1/4" x 11A	1060-114-A65

Cylinders

If you know ... then you know

OLD CORBIN OR RUSSWIN	CORBIN RUSSWIN
5253-1/2 1-3/8"	1060-138-A63
5253-1/2 1-3/8" x 1A	1060-138-A62
5253-1/2 1-3/8" x 11A	1060-138-A65
5253-1/2 1-1/2"	1060-112-A63
5253-1/2 1-1/2" x 1A	1060-112-A62
5253-1/2 1-1/2" x 11A	1060-112-A65
5253-1/2 1-3/4"	1060-134-A63
5253-1/2 1-3/4" x 1A	1060-134-A62
5253-1/2 1-3/4" x 11A	1060-134-A65
5253-1/2 2"	1060-200-A63
5253-1/2 2" x 1A	1060-200-A62
5253-1/2 2" x 11A	1060-200-A65
5253-1/2 2-1/4"	1060-214-A63
5253-1/2 2-1/4" x 1A	1060-214-A62
5253-1/2 2-1/4" x 11A	1060-214-A65
5253-1/2 2-1/2"	1060-212-A63
5253-1/2 2-1/2" x 1A	1060-212-A62
5253-1/2 2-1/2" x 11A	1060-212-A65
5253-1/2 2-3/4"	1060-234-A63
5253-1/2 2-3/4" x 1A	1060-234-A62
5253-1/2 2-3/4" x 11A	1060-234-A65
5253-1/2 3"	1060-300-A63
5253-1/2 3" x 1A	1060-300-A62
5253-1/2 3" x 11A	1060-300-A65
5263 1-1/8"	1000-118-A04
5263 1-1/4"	1000-114-A04
5263 1-1/4" 7P	1000-114-A04-7
5263 1-3/8"	1000-138-A04
5263 1-3/8" 7P	1000-138-A04-7
5263 1-1/2"	1000-112-A04
5263 1-1/2" 7P	1000-112-A04-7
5263 1-3/4"	1000-134-A04
5263 1-3/4" 7P	1000-134-A04-7
5263 2-1/4"	1000-214-A04
5263 2-1/4" 7P	1000-214-A04-7
5263 2-1/2"	1000-212-A04
5263 2-1/2" 7P	1000-212-A04-7
5263 2-3/4"	1000-234-A04
5263 2-3/4" 7P	1000-234-A04-7
5263 3"	1000-300-A04
5263 3" 7P	1000-300-A04-7
5263-1/2 1"	1060-100-A64-5
5263-1/2 1-1/8"	1060-118-A64
5263-1/2 1-1/4"	1060-114-A64
5263-1/2 1-3/8"	1060-138-A64
5263-1/2 1-1/2"	1060-112-A64
5263-1/2 1-3/4"	1060-134-A64
5263-1/2 2"	1060-200-A64
5263-1/2 2-1/4"	1060-214-A64
5263-1/2 2-1/2"	1060-212-A64

If you know ... then you know

OLD CORBIN OR RUSSWIN	CORBIN RUSSWIN
5263-1/2 2-3/4"	1060-234-A64
5263-1/2-300	1060-300-A64
5281	3080-178
5281 7P	3080-178-7
W5281	3090-178
5283 1-1/4"	1080-114-A02
5283 1-3/8"	1080-138-A02
5283 1-1/2"	1080-112-A02
5283 1-1/2" 7P	1080-112-A02-7
5283 1-3/4"	1080-134-A02
5283 1-3/4" 7P	1080-134-A02-7
5283 A 1-1/4"	1080-114-A03
5283 A 1-3/8"	1080-138-A03
5283 A 1-1/2"	1080-112-A03
5283 A 1-1/2" 7P	1080-112-A03-7
5283 A 1-3/4"	1080-134-A03
5283 A 1-3/4" 7P	1080-134-A03-7
5283 B 1-1/4"	1080-114-A05
5283 B 1-3/8"	1080-138-A05
5283 B 1-1/2"	1080-112-A05
5283 B 1-1/2" 7P	1080-112-A05-7
5283 B 1-3/4"	1080-134-A05
5283 B 1-3/4" 7P	1080-134-A05-7
5283 J 1-1/4"	1080-114-A04
5283 J 1-3/8"	1080-138-A04
5283 J 1-1/2"	1080-112-A04
5283 J 1-1/2" 7P	1080-112-A04-7
5283 J 1-3/4"	1080-134-A04
5283 J 1-3/4" 7P	1080-134-A04-7
P5283	8000
P5283 7P	8000-7
P5283HC	8001-042
W5283 1-1/4"	1090-114-A02
W5283 1-3/8"	1090-138-A02
W5283 1-1/2"	1090-112-A02
W5283 1-3/4"	1090-134-A02
W5283 A 1-1/4"	1090-114-A03
W5283 A 1-3/8"	1090-138-A03
W5283 A 1-1/2"	1090-112-A03
W5283 A 1-3/4"	1090-134-A03
W5283 B 1-1/4"	1090-114-A05
W5283 B 1-3/8"	1090-138-A05
W5283 B 1-1/2"	1090-112-A05
W5283 B 1-3/4"	1090-134-A05
W5283 J 1-1/4"	1090-114-A04
W5283 J 1-3/8"	1090-138-A04
W5283 J 1-1/2"	1090-112-A04
W5283 J 1-3/4"	1090-134-A04
WP5283	8010
WP5283H	8011-042
5283-1/4 1-1/4"	1080-114-A01
5283-1/4 1-3/8"	1080-138-A01

Nomenclature Made Easy!
Conversion Chart



Numbers

If you know then you know
OLD CORBIN OR RUSSWIN	CORBIN RUSSWIN
5283-1/4 1-1/2"	1080-112-A01
5283-1/4 1-1/2" 7P	1080-112-A01-7
5283-1/4 1-3/4"	1080-134-A01
5283-1/4 1-3/4" 7P	1080-134-A01-7
5283-1/4 H	1081-138-A01
W5283-1/4 1-1/4"	1090-114-A01
W5283-1/4 1-3/8"	1090-138-A01
W5283-1/4 1-1/2"	1090-112-A01
W5283-1/4 1-3/4"	1090-134-A01
W5283-1/4H	1091-138-A01
W5291	3012-178
W5291T	3012-178V
W5293	1012-114-A02
W5293 A	1012-114-A03
W5293 B	1012-114-A05
W5293 J	1012-114-A04
W5293-1/4	1012-114-A01
5353 1"	1100-100-A02
5353 1-1/8"	1100-118-A02
5353 1-1/8" 7P	1100-118-A02-7
5353 1-1/4"	1100-114-A02
5353 1-1/4" 7P	1100-114-A02-7
5353-1/4 1"	1100-100-A01
5353-1/4 1-1/8"	1100-118-A01
5353-1/4 1-1/8" 7P	1100-118-A01-7
5353-1/4 1-1/4"	1100-114-A01
5353-1/4 1-1/4" 7P	1100-114-A01-7
5353-1/4H	1101-118-A01
5353-1/2 1"	1160-100-A63
5353-1/2 1" x 1A	1160-100-A62
5353-1/2 1" x 11A	1160-100-A65
5353-1/2 1-1/8"	1160-118-A63
5353-1/2 1-1/8" x 1A	1160-118-A62
5353-1/2 1-1/8" x 11A	1160-118-A65
5353-1/2 1-1/4"	1160-114-A63
5353-1/2 1-1/4" x 1A	1160-114-A62
5353-1/2 1-1/4" x 11A	1160-114-A65
5460 R	2000-052
5460 T	2100-052
W5460FH	2011-052
W5460R	2010-052
5460-1/2FH	2061-042
5460-1/2R	2060-052
5460-1/2T	2160-052
5811	discontinued
7110	discontinued
7110-1/2	discontinued
7111	discontinued
7111-1/2	discontinued
7191	discontinued
8253 1"	discontinued
8253 1-1/4"	discontinued
8253 1-1/8"	discontinued

Cylinders

If you know then you know
OLD CORBIN OR RUSSWIN	CORBIN RUSSWIN
8253 1-3/8"	discontinued
8253-1/4 1"	discontinued
8253-1/4 1-1/8"	discontinued
8253-1/4 1-1/4"	discontinued
8253-1/4 1-3/8"	discontinued
8291	3080-178
8291 7P	3080-178-7
W8291	3090-178
11100	1200-100-A01
11100-1/2	1200-118-A01
11101	1200-114-A01
11101-1/2	1200-138-A01
11102	1200-112-A01
S-18397 1"	1160W-100-A63
S-18397 1-1/8"	1160W-118-A63
26400-4	discontinued
26400-5	discontinued
56400-3	2001-051
56400-4	discontinued
56400-5	discontinued
61001	1100-100-A02
MR61001	1160-100-A62
61002	1100-100-A01
MR61002	1160-100-A65
MR61003	1160-100-A63
61141	1100-114-A02
MR61141	1160-114-A62
61142	1100-114-A01
MR61142	1160-114-A65
MR61143	1160-114-A63
61181	1100-118-A02
MR61181	1160-118-A62
61182	1100-118-A01
61182HM	1101-118-A01
MR61182	1160-118-A65
MR61183	1160-118-A63
71141	1100-114-A02-7
71142	1100-114-A01-7
71181	1100-118-A02-7
71182	1100-118-A01-7
81121	1080-112-A02
81121 7P	1080-112-A02-7
81121C 7P	1080-112-A93-7
81121A	1080-112-A03
81121A 7P	1080-112-A03-7
81121B	1080-112-A05
81121B 7P	1080-112-A05-7
81121C	1080-112-A93
81121J	1080-112-A04
81121J 7P	1080-112-A04-7
W81121	1090-112-A02
W81121A	1090-112-A03

If you know then you know
OLD CORBIN OR RUSSWIN	CORBIN RUSSWIN
W81121B	1090-112-A05
W81121C	1090-112-A93
W81121J	1090-112-A04
81122	1080-112-A01
81122 7P	1080-112-A01-7
W81122	1090-112-A01
81141	1080-114-A02
81141A	1080-114-A03
81141B	1080-114-A05
81141C	1080-114-A93
81141J	1080-114-A04
W81141	1090-114-A02
W81141A	1090-114-A03
W81141B	1090-114-A05
W81141C	1090-114-A93
W81141J	1090-114-A04
81142	1080-114-A01
W81142	1090-114-A01
81341	1080-134-A02
81341 7P	1080-134-A02-7
81341A	1080-134-A03
81341A 7P	1080-134-A03-7
81341B	1080-134-A05
81341B 7P	1080-134-A05-7
81341J	1080-134-A04
81341J 7P	1080-134-A04-7
W81341	1090-134-A02
W81341A	1090-134-A03
W81341B	1090-134-A05
W81341J	1090-134-A04
81342	1080-134-A01
81342 7P	1080-134-A01-7
W81342	1090-134-A01
81381	1080-138-A02
81381A	1080-138-A03
81381B	1080-138-A05
81381C	1080-138-A93
81381J	1080-138-A04
W81381	1090-138-A02
W81381A	1090-138-A03
W81381B	1090-138-A05
W81381C	1090-138-A93
W81381J	1090-138-A04
81382	1080-138-A01
81382HM	1081-138-A01
W81382	1090-138-A01
W81382HM	1091-138-A01
144K15	2060-052
144F16	2000-052
186K78	2001-051
195K69	4266-001-A02
195K70	4266-001-A02

Nomenclature Made Easy!
Conversion Chart

Cylinders

Numbers

If you know then you know
OLD CORBIN OR RUSSWIN	CORBIN RUSSWIN
245K39	2160-052
245K40	2100-052
334F16	1070-114-A02
334F17	1070-112-A02
334F18	1070-114-A01
334F19	1070-112-A01
334F24	3070-178
353F88	1071-138-A01
354F10	1070-138-A02
354F11	1070-138-A01
364F07	1070-114-A05
364F08	1070-112-A05
364F09	1070-138-A05
364F10	1070-114-A03
364F11	1070-112-A03
364F12	1070-138-A03
364F13	1070-114-A93
364F14	1070-112-A93
364F15	1070-138-A93
374K38	2061-052
399K19	1000-118-A91
399K20	1000-114-A91-7
399K46	4266-001-A92
399K47	4266-001-A92
404K60	1000-118-A91
404K61	1000-114-A91-7
406K51	discontinued
406K52	discontinued
416F16	3070-178-7
416F17	1070-112-A02-7
416F18	1070-112-A01-7
416F19	1070-112-A05-7
416F20	1070-112-A03-7
416F21	1070-112-A93-7
416K72	discontinued
416K73	discontinued
416K74	discontinued
423F50	1070-114-A04
427W52	1010-118-A04
427W53	1010-118-A04
445K00	2200-054
445K01	2200-001-A21
445K02	2200-002-A21
445K03	2200-003-A24
445K04	2200-008
445W05	2210-054
445W06	2210-001-A21
445W07	2210-002-A21
445W08	2210-003-A24
445W09	2210-008
446W92	1090-114-A04
447W11	1090-114-A04

If you know then you know
OLD CORBIN OR RUSSWIN	CORBIN RUSSWIN
461K11	2200-002-A22
464K99	1004-118-A02
467F38	1300-118-A03
467F39	1300-114-A03
467F40	1300-138-A03
467F41	1303-118-A03
467F42	1303-114-A03
467F43	1303-138-A03
481W20	1014-118-A02
481W21	1014-118-A02
481W29	1015-118-A02
481W30	1015-118-A02
489K05	2000-052
489K06	2000-052
489K09	2000-051
489K10	2000-051
489K11	2001-042
489K12	2001-042
489K13	2000-052
489K15	2000-051
489K16	2001-042
489K51	2001-051
490K57	3000-138
490K59	3000-138
497F50	1070-134-A02
497F51	1070-134-A02-7
497F76	1070-134-A01
497F77	1070-134-A01-7
519K52	use 3000-138
519K54	use 3000-138
520K36	2200-002-A23
522W70	4210-001-A42
522W71	4210-001-A43
522W72	4210-001-A45
522W73	4210-001-A46
522W74	4210-001-A41
522W75	4210-001-A44
522K78	4200-001-A42
522K79	4200-001-A43
522K80	4200-001-A45
522K81	4200-001-A46
522K82	4200-001-A41
522K83	4200-001-A44
522K85	4200-001-A42
522K86	4200-001-A43
522K87	4200-001-A45
522K88	4200-001-A46
522K89	4200-001-A41
522K90	4200-001-A44
523K22	2200-076
526K68	use 2000-051
526K69	use 2000-051

If you know then you know
OLD CORBIN OR RUSSWIN	CORBIN RUSSWIN
556W57	2010-051
556W58	2010-051
559K96	1004-118-A02
559K97	1005-118-A02
559K98	1005-118-A02
560K24	1004-118-A02
560K25	1005-118-A02
561K70	4200-001-A42
561K71	4200-001-A43
561K72	4200-001-A45
561K73	4200-001-A46
561K74	4200-001-A41
561K75	4200-001-A44
561W90	4210-001-A42
561W91	4210-001-A43
561W92	4210-001-A45
561W93	4210-001-A46
561W94	4210-001-A41
561W95	4210-001-A44
564K51	2001-044
564K54	2003-044
564K55	2000-044
564K56	2001-044
564K57	2003-044
564K58	2000-044
564K59	2001-044
574K00	2001-066
574K01	2003-044
574K02	2000-044
585K41	2000-034
585K42	2000-034-7
585K43	2001-034
585K44	2001-034-7
585W45	2010-034
594F63	1070-112-A04-7
594K64	1080-112-A04-7
594K65	1080-112-A04-7
596K21	2000-034
596K22	2000-034
596K23	2000-034-7
596K24	2000-034-7
596K25	2001-034
596K26	2001-034
596K27	2001-034-7
596K28	2001-034-7
596W33	2010-034
600K82	8001-034
600K83	8001-034
600K84	8001-034
600K88	8001-034-7
600K89	8001-034-7
600K90	8001-034-7

Nomenclature Made Easy!
Conversion Chart

Door Closers

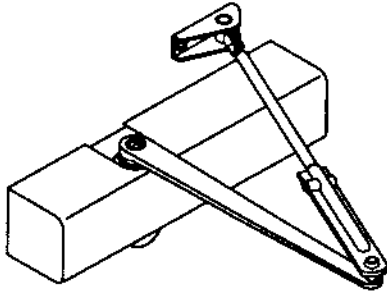

Ordering Configuration

Qty	Series/Application/Size	Arm	Finish	Hand	Options
100	DC2416	A1	689	RH	M54-M73

Series Numbers

If you know ...

... then you know

Corbin	Russwin	Description	Corbin Russwin
120	2820	Door Closer	DC2200
110	2810	Door Closer	DC2400
100	2800	Door Closer	DC2600
390E	R9120	Door Closer	DC3200
290E	R9100	Door Closer	DC3600
190E	R9000	Door Closer	DC4600 (with option M88)
90	90	Door Closer	DC4600

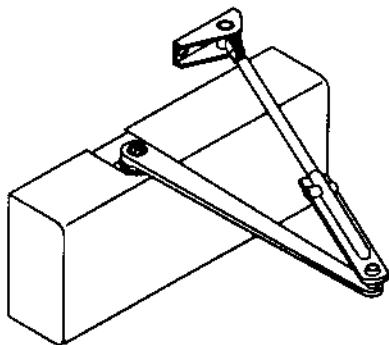

Electromechanical Door Closers

Ordering Configuration

Qty	Series/Application/Size	Arm	Finish	Hand	Options
100	DC26900	A1	689	RH	M54-M73

Series Numbers

If you know ...

... then you know

Corbin	Russwin	Description	Corbin Russwin
200	2900	Electromechanical Door Closer	DC26900
2200	2200	Electromechanical Door Closer	DC46920
2300	2300	Electromechanical Door Closer	DC46930

Door Holders and Releases

Nomenclature Made Easy!
Conversion Chart

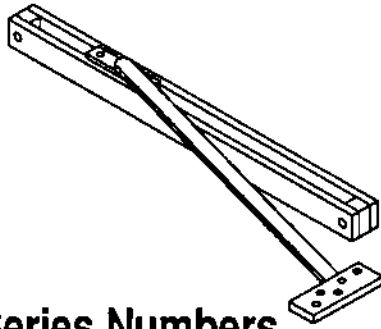

Series Numbers

If you know ...

Corbin	Ruswin	Description	Corbin	Ruswin
865	1650	Surface – Three Way, Bronze	DH5201	
1865	ST1650	Surface – Three Way, Steel	DH5201S	
765	1660	Surface – Free Acting, Bronze	DH5202	
1765	ST1660	Surface – Free Acting, Steel	DH5202S	
775	1670	Surface – Non-Hold-Open, Bronze	DH5203	
1775	ST1670	Surface – Non-Hold-Open, Steel	DH5203S	
1550	1550	Surface – Positive Grip	DH5401	
1555	1555	Surface – Door Stay	DH5402	
810	520	Surface – Adjustable	DH5600	

Door Holders

Ordering Configuration

Qty	Series	Finish	Door Thick.	Door Width	Options
100	DH5401	626	D214	W35	M88

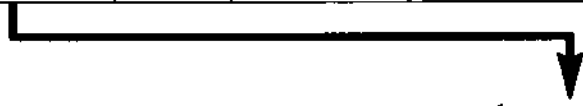

... then you know

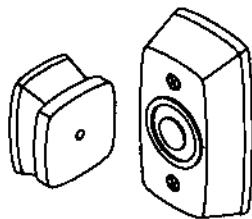

Electromagnetic Door Releases

Ordering Configuration

Qty	Number	Finish
100	DH57903	690



Numbers

If you know ...

Corbin	Ruswin	Description	Corbin	Ruswin
MA201	MA201	Electromagnetic Door Release	DH57901	
MA203	MA203	Electromagnetic Door Release	DH57903	
MA204	MA204	Electromagnetic Door Release	DH57904	
MA241	MA241	Electromagnetic Door Release	DH57941	
MA243	MA243	Electromagnetic Door Release	DH57943	
MA244	MA244	Electromagnetic Door Release	DH57944	

Nomenclature Made Easy!
Conversion Chart

Finishes

Ordering Configuration

Qty	Series/Function	Trim	Finish	Hand	Options
100	ML2255	LSM	626	LH	D214

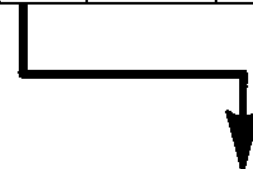

Finish Numbers

If you know . . .	Description	. . . then you know
US3	Polished Brass	BHMA 605
US4	Satin Brass	BHMA 606
US9	Polished Bronze	BHMA 611
US10	Satin Bronze	BHMA 612
US10B	Oil Rubbed Bronze	BHMA 613
US14	Bright Nickel (matches US32)	BHMA 618
US15	Satin Nickel (matches US32D)	BHMA 619
US19	Flat Black Coated	BHMA 622
US26	Polished Chrome	BHMA 625
US26D	Satin Chrome	BHMA 626
US32	Polished Stainless Steel	BHMA 629
US32D	Satin Stainless Steel	BHMA 630
<hr/>		
USP	Primed for Painting	BHMA 600
SBL	Silver Aluminum Lacquer	BHMA 689
LBL	Dark Bronze Lacquer	BHMA 690
DBL	Dull Bronze Lacquer	BHMA 691
FBL	Flat Black Lacquer	BHMA 693
GBL	Gold Brass Lacquer	BHMA 696

For more information regarding Corbin Russwin Locksets,
Exit Devices, Door Controls and Key Systems, contact your
authorized Corbin Russwin Distributor or Sales Representative.

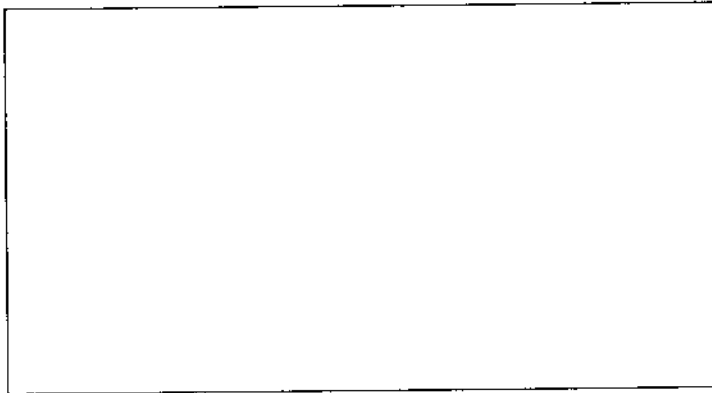

In U.S:
Corbin Russwin Architectural Hardware
225 Episcopal Road
Berlin, CT 06037 USA
Phone 203-225-7411 Fax 203-828-7266

In Canada:
Corbin Russwin Canada
3160 Orlando Drive
Mississauga, Ontario L4V 1R5
Phone 800-461-3007 or 905-672-6220
Fax 800-461-8989 or 905-672-9022